

CHARACTERISTICS

		STANDARD	AVAILABLE OPTIONS
Filtration		4 + 1 mm (two grids)	
Ports		DN 100 ISO PN16 Flanges	
Dimensions mm (in.)	D	151 (5.95)	
	E	132 (5.20)	
	F	159 (6.26)	
	G	140 (5.51)	
	L	319 (12.56)	
Weight kg (lbs)		25 (55.11)	

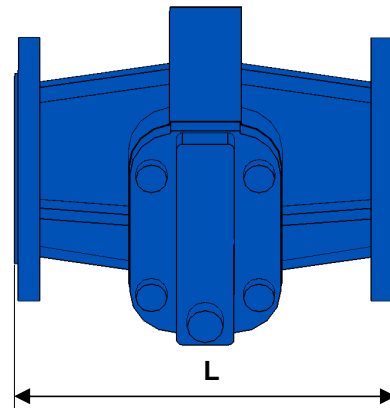
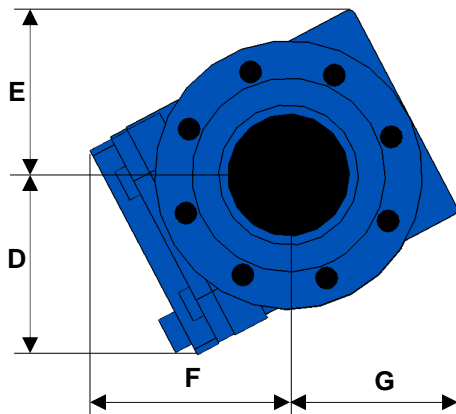

OPERATING LIMITS

	STANDARD MATERIALS	AVAILABLE OPTIONS
Minimum temperature °C (°F)	-10 (14)	
Maximum temperature °C (°F)	110 (230)	
Maximum working pressure bar (psi)	4 (58)	

MATERIALS OF CONSTRUCTION

Part No	PART NAME	STANDARD MATERIALS	AVAILABLE OPTIONS
2	Casing	Cast iron	
5	Cover	Cast iron	
6	4 mm grid (welded on cover)	Carbon steel	Stainless steel
6a	1 mm grid (removable)	Carbon steel	Stainless steel
	Screws	Carbon steel	
	Gaskets	Fibber Asbestos free	