

EOM

ENGINEERING OPERATION
& MAINTENANCE MANUAL

PS2

Saniflo™ Hygienic™ Series Clamped Metal Pump

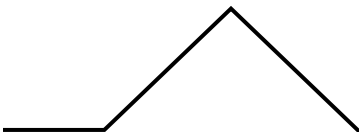

Where Innovation Flows

WILDEN®



Copyright

Copyright 2018 PSG®, a Dover Company. All rights reserved.

PSG reserves the right to modify the information and illustrations in this document without prior notice. The product described in this document is furnished under a license agreement or nondisclosure agreement. No part of this document may be reproduced, stored in a retrieval system, or transmitted in any form or any means electronic or mechanical, including photocopying and recording, without the written permission of PSG, a Dover Company, except as described by the terms of those agreements.

This is a non-contractual document.

Trademarks

PSG and the PSG logo are registered trademarks of PSG. Wilden® is a registered trademark of PSG California LLC. Pro-Flo® SHIFT, Pro-Flo®, and Wil-Flex® are registered trademarks of PSG California LLC. Chem-Fuse™, Pure-Fuse™, Saniflex™, and Bunalast™ are trademarks of PSG California LLC.

All trademarks, names, logos and service marks (collectively “trademarks”) in this document are registered and unregistered trademarks of their respective owners. Nothing contained in this document should be construed as granting any license or right to use any trademark without the prior written permission of the trademark owner.

Warranty

Each and every product manufactured by Wilden is built to meet the highest standards of quality. Every pump is functionally tested to ensure integrity of operation. Wilden warrants that pumps, accessories and parts manufactured or supplied by it to be free from defects in material and workmanship for a period of five (5) years from date of installation or six (6) years from date of manufacture, whichever comes first.

For more information, and to register your Wilden pump for warranty, please visit <https://www.psgdover.com/wilden/support/warranty-registration>.

Certifications



CONTENTS

SECTION 1: Precautions – Read First!	4
SECTION 2: Wilden Pump Designation System	5
SECTION 3: How It Works	6
SECTION 4: Dimensional Drawings	7
SECTION 5: Performance	8
PS2 Saniflo HS Rubber-Fitted	8
PS2 Saniflo HS TPE Integral Piston Diaphragm-Fitted	8
PS2 Saniflo HS Full-Stroke TPE-Fitted	9
PS2 Saniflo HS Full-Stroke PTFE-Fitted	9
Suction Lift Capability	10
SECTION 6: Suggested Installation, Operation, Maintenance, and Troubleshooting	11
SECTION 7: Disassembly/Reassembly	14
Pump Disassembly	14
Wil-Gard™ Diaphragm Sensor	17
Swivel Pump Stand Option	18
Air Valve/Center Section Disassembly	19
Single-Point Exhaust	22
Reassembly Hints and Tips	22
SECTION 8: Clean-in-Place (CIP)	24
SECTION 9: Exploded View and Parts List	25
SECTION 10: Elastomer Options	28
SECTION 11: Declaration of Conformity	29

SECTION 1

PRECAUTIONS – READ FIRST!



WARNING: Always wear safety glasses when operating a pump to avoid eye injury. If diaphragm rupture occurs, material being pumped may be forced out of the air exhaust.



CAUTION: Do not apply compressed air to the exhaust port – pump will not function.



CAUTION: Do not over-lubricate air supply– excess lubrication will reduce pump performance. Pump is pre-lubed.



TEMPERATURE LIMITS:

Acetal	-29°C to 82°C	-20°F to 180°F
Buna-N	-12°C to 82°C	10°F to 180°F
Bunast™	-40°C to 137°C	-40°F to 266°F
Geolast®	-40°C to 82°C	-40°F to 180°F
Neoprene	-18°C to 93°C	0°F to 200°F
Nordel® EPDM	-51°C to 138°C	-60°F to 280°F
Nylon	-18°C to 93°C	0°F to 200°F
PFA	-7°C to 107°C	45°F to 225°F
Polypropylene	0°C to 79°C	32°F to 175°F
Polyurethane	-12°C to 66°C	10°F to 150°F
PVDF	-12°C to 107°C	10°F to 225°F
Saniflex™	-29°C to 104°C	-20°F to 220°F
SIPD PTFE with EPDM-backed	4°C to 137°C	40°F to 280°F
SIPD PTFE with Neoprene-backed	4°C to 93°C	40°F to 200°F
PTFE*	4°C to 104°C	40°F to 220°F
FKM	-40°C to 177°C	-40°F to 350°F
Wil-Flex®	-40°C to 107°C	-40°F to 225°F

*4°C to 149°C (40°F to 300°F) - 13 mm (1/2") and 25 mm (1") models only.

NOTE: Not all materials are available for all models. See "Wilden Pump Designation System" for material options for your pump.



CAUTION: When choosing pump materials, be sure to check the temperature limits for all wetted components. Example: FKM has a maximum limit of 177°C (350°F), but polypropylene has a maximum limit of only 79°C (175°F).



CAUTION: Maximum temperature limits are based on mechanical stress only. Certain chemicals will reduce maximum safe operating temperatures significantly. Consult the Chemical Resistance Guide for chemical compatibility and temperature limits.



CAUTION: All Wilden pumps are capable of passing solids. Use a strainer on the pump intake to ensure that the pump's rated solids capacity is not exceeded.



CAUTION: Do not exceed 8.6 bar (125 psig) air supply pressure.



CAUTION: Do not exceed 82°C (180°F) air inlet temperature for all models.



CAUTION: The process fluid and cleaning fluids must be compatible chemically with all wetted pump components.



CAUTION: Before attempting any maintenance or repair, disconnect the compressed air line to the pump and allow all air pressure to bleed from the pump. Disconnect all intake, discharge, and air lines. Drain the pump by turning it upside down and allowing any fluid to flow into a suitable container. Be aware of any hazardous effects of contact with your process fluid.



CAUTION: Thoroughly flush pumps before installing them into process lines. Clean and/or sanitize FDA- and USDA- approved pumps before using them.



CAUTION: Before attaching the air line to the pump, blow out the air line for 10 to 20 seconds to make sure all pipeline debris is clear. Use an in-line air filter. A 5µ (micron) air filter is recommended.



CAUTION: Pro-Flo pumps cannot be used in submersible applications. Pro-Flo SHIFT is available in both single-point exhaust (submersible) and standard (non-submersible) options. Do not use standard Pro-Flo SHIFT models in submersible applications.



CAUTION: Before installation, tighten all hardware.



CAUTION: When selecting pump materials for food and beverage service, be sure to review compatibility limits for all wetted components.

Example: Wil-Flex material is not recommended for oily and fatty foods. Consult the manufacturer for the full range of solutions.



NOTE: Materials of construction and elastomer material may influence suction lift parameters. Please refer to "Performance" for specifics.



NOTE: When installing PTFE diaphragms, it is important to tighten outer pistons simultaneously (turning in opposite directions) to ensure tight fit. (See "Maximum Torque Specifications").



NOTE: Some PTFE-fitted pumps come standard from the factory with expanded PTFE gaskets installed in the diaphragm bead of the liquid chamber. PTFE gaskets cannot be re-used.



NOTE: In the event of a power failure, close the shut-off valve if you do not want the pump to restart when the power returns.



NOTE: The Safety Supplement document is a part of the manual. Please refer to the Safety Supplement document for a complete list of safety considerations including considerations for safe operation and maintenance of pumps marked for ATEX environments before starting the pump.



WARNING: This product can expose you to chemicals including Nickel, Chromium, Cadmium, or Cobalt, which are known to the State of California to cause cancer and/or birth defects or other reproductive harm. For more information, go to www.P65Warnings.ca.gov.

SECTION 2

WILDEN PUMP DESIGNATION SYSTEM

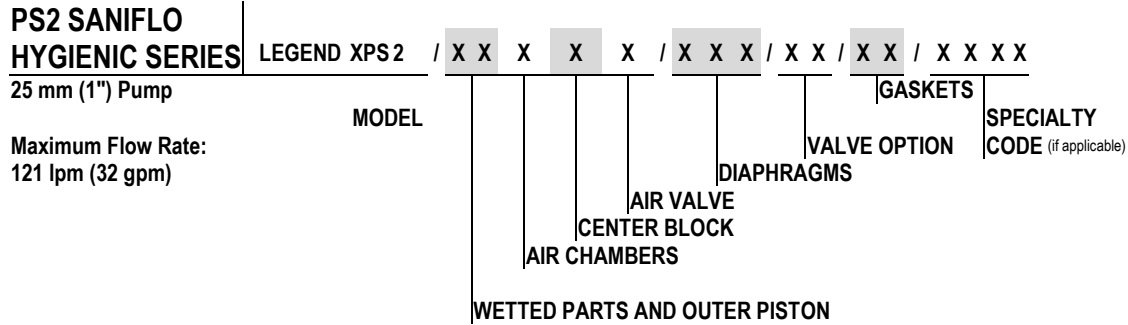

MATERIAL CODES

MODEL	DIAPHRAGMS	BALL VALVES
XPS2 = PRO-FLO® SHIFT ATEX PS2 = PRO-FLO® SHIFT	FES = SANITARY EPDM ^{1,4} (TWO BLUE DOTS) FSL = FULL-STROKE SANITARY SANIFLEX™ IPD ^{1,3,4} [HYTREL® (CREAM)] FSS = SANIFLEX™ ^{1,4} [HYTREL® (CREAM)] FWL = SANITARY WIL-FLEX®, IPD ^{1,3} [SANTOPRENE® (TWO BLACK DOTS)] FWS = SANITARY WIL-FLEX®, EZ-INSTALL ¹ [SANTOPRENE® (TWO BLACK DOTS)] LEL = PTFE IPD ^{1,2,3,4} TEU = PTFE W/EPDM BACKUP ^{1,2,4} TSS = FULL-STROKE PTFE ^{1,2,4} W/SANIFLEX™ BACK-UP TSU = FULL-STROKE PTFE ^{1,2,4} W/SANIFLEX™ BACK-UP TWS = FULL-STROKE PTFE ^{1,2} W/WIL-FLEX® BACK-UP	FE = SANITARY EPDM ^{1,3,4} (TWO BLUE DOTS) FS = SANIFLEX™ ^{1,3,4} [HYTREL® (CREAM)] FW = SANITARY WIL-FLEX® ^{1,3,4} [SANTOPRENE® (TWO BLACK DOTS)] TF = PTFE ^{1,2,3,4} (WHITE)
WETTED PARTS AND OUTER PISTON		GASKETS
SS = STAINLESS STEEL SZ = STAINLESS STEEL/NO PISTON		FE = SANITARY EPDM ^{1,3,4} (TWO BLUE DOTS) FV = SANITARY FKM ^{1,3,4} (TWO WHITE DOTS) TF = PTFE ^{1,2,3,4}
AIR CHAMBERS		NOTES:
N = NICKEL-PLATED ALUMINUM		¹ Meets Requirements of FDA CFR21.177 ² Meets Requirements of USP Class VI ³ Required for 3-A Certification ⁴ Meets Requirements of 1935/2004/EC
CENTER BLOCK		
N = NICKEL-PLATED ALUMINUM		
AIR VALVE		
N = NICKEL-PLATED ALUMINUM		

SPECIALTY CODES

0770 Saniflo HS	0770E Saniflo HS (1935/2004/EC)
0771 Saniflo HS, w/Swivel Stand	0771E Saniflo HS, w/Swivel Stand (1935/2004/EC)
0772 Saniflo HS, Wil-Gard 110V	0772E Saniflo HS, Wil-Gard 110V (1935/2004/EC)
0773 Saniflo HS, Wil-Gard 220V	0773E Saniflo HS, Wil-Gard 220V (1935/2004/EC)
0774 Saniflo HS, Wil-Gard 110V, w/Swivel Stand ³	0774E Saniflo HS, Wil-Gard 110V, w/Swivel Stand (1935/2004/EC)
0775 Saniflo HS, Wil-Gard 220V, w/Swivel Stand ³	0775E Saniflo HS, Wil-Gard 220V, w/Swivel Stand (1935/2004/EC)
0778 Saniflo HS, DIN Connection	0778E Saniflo HS, DIN Connection (1935/2004/EC)
0779 Saniflo HS, w/Swivel Stand DIN Connection	0779E Saniflo HS, w/Swivel Stand DIN Connection (1935/2004/EC)
0780 Saniflo HS, Wil-Gard 110V DIN Connection	0780E Saniflo HS, Wil-Gard 110V DIN Connection (1935/2004/EC)
0781 Saniflo HS, Wil-Gard 220V DIN Connection	0781E Saniflo HS, Wil-Gard 220V DIN Connection (1935/2004/EC)
0782 Saniflo HS, Wil-Gard 110V, w/Swivel Stand DIN Connection	0782E Saniflo HS, Wil-Gard 110V, w/Swivel Stand DIN Connection (1935/2004/EC)
0783 Saniflo HS, Wil-Gard 220V, w/Swivel Stand DIN Connection	0783E Saniflo HS, Wil-Gard 220V, w/Swivel Stand DIN Connection (1935/2004/EC)
0784 Saniflo HS, SMS Connection	0784E Saniflo HS, SMS Connection (1935/2004/EC)
0785 Saniflo HS, w/Swivel Stand SMS Connection	0785E Saniflo HS, w/Swivel Stand SMS Connection (1935/2004/EC)
0786 Saniflo HS, Wil-Gard 110V SMS Connection	0786E Saniflo HS, Wil-Gard 110V SMS Connection (1935/2004/EC)
0787 Saniflo HS, Wil-Gard 220V SMS Connection	0787E Saniflo HS, Wil-Gard 220V SMS Connection (1935/2004/EC)
0788 Saniflo HS, Wil-Gard 110V, w/Swivel Stand SMS Connection	0788E Saniflo HS, Wil-Gard 110V, w/Swivel Stand SMS Connection (1935/2004/EC)
0789 Saniflo HS, Wil-Gard 220V, w/Swivel Stand SMS Connection	0789E Saniflo HS, Wil-Gard 220V, w/Swivel Stand SMS Connection (1935/2004/EC)

! NOTE: Most elastomeric materials use colored dots for identification

! NOTE: Not all models may be available with all material options

SECTION 3

HOW IT WORKS – AIR-OPERATED DOUBLE-DIAPHRAGM PUMP

The Wilden diaphragm pump is an air-operated, positive displacement, self-priming pump. These drawings show flow pattern through the pump upon its initial stroke. It is assumed the pump has no fluid in it prior to its initial stroke.

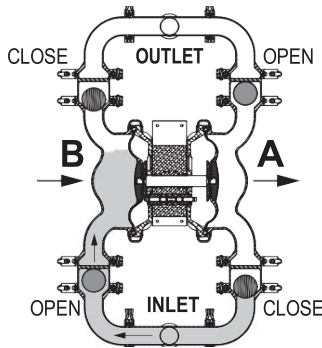

FIGURE 1 The air valve directs pressurized air to the back side of diaphragm A. The compressed air is applied directly to the liquid column separated by elastomeric diaphragms. The diaphragm acts as a separation membrane between the compressed air and liquid; a balanced load removes mechanical stress from the diaphragm. The compressed air moves the diaphragm away from the center of the pump. The opposite diaphragm is pulled in by the shaft connected to the pressurized diaphragm. Diaphragm B is on its suction stroke; air behind the diaphragm has been forced out to atmosphere through the exhaust port of the pump. The movement of diaphragm B toward the center of the pump creates a vacuum within chamber B. Atmospheric pressure forces fluid into the inlet manifold forcing the inlet valve ball off its seat. Liquid is free to move past the inlet valve ball and fill the liquid chamber (see shaded area).

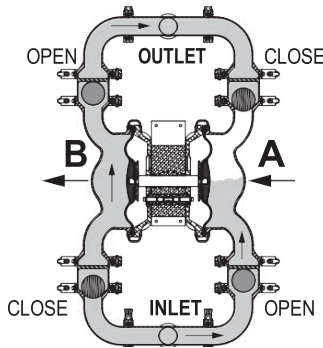

FIGURE 2 When the pressurized diaphragm, diaphragm A, reaches the limit of its discharge stroke, the air valve redirects pressurized air to the back side of diaphragm B. The pressurized air forces diaphragm B away from the center while pulling diaphragm A to the center. Diaphragm B is now on its discharge stroke. Diaphragm B forces the inlet valve ball onto its seat due to the hydraulic forces developed in the liquid chamber and manifold of the pump. These same hydraulic forces lift the discharge valve ball off its seat, while the opposite discharge valve ball is forced onto its seat, forcing fluid to flow through the pump discharge. The movement of diaphragm A toward the center of the pump creates a vacuum within liquid chamber A. Atmospheric pressure forces fluid into the inlet manifold of the pump. The inlet valve ball is forced off its seat allowing the fluid being pumped to fill the liquid chamber.

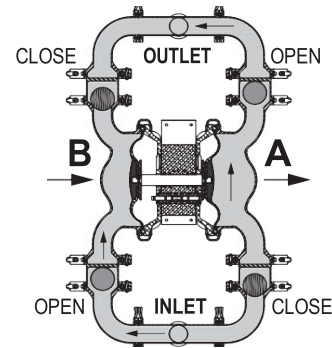
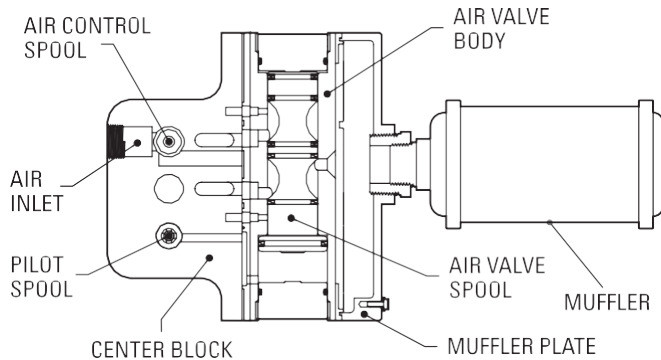

FIGURE 3 At completion of the stroke, the air valve again redirects air to the back side of diaphragm A, which starts diaphragm B on its exhaust stroke. As the pump reaches its original starting point, each diaphragm has gone through one exhaust and one discharge stroke. This constitutes one complete pumping cycle. The pump may take several cycles to completely prime depending on the conditions of the application.

HOW IT WORKS – AIR DISTRIBUTION SYSTEM



The heart of the patented Pro-Flo® SHIFT Air Distribution System (ADS) is the air valve assembly. The air valve design incorporates an unbalanced spool with the small end of the spool being pressurized continuously while the large end of the spool is alternately pressurized, then exhausted to move the spool. The air valve spool directs pressurized air to one chamber while exhausting the other. The air forces the main shaft/diaphragm assembly to move to one side – discharging liquid on that side and pulling liquid in on the other side. When the shaft reaches the end of the stroke, the inner piston actuates the pilot spool, which controls the air to the large end of the air valve spool. The repositioning of the air valve spool routes the air to the other air chamber. The air control spool allows air to flow freely into the air chamber for the majority of each pump stroke, but it significantly restricts the flow of air into the air chamber when activated by the inner piston near the end of each stroke.

SECTION 4

DIMENSIONAL DRAWING

PS2 SANIFLO™ HYGIENIC™ SERIES – SWIVEL STAND

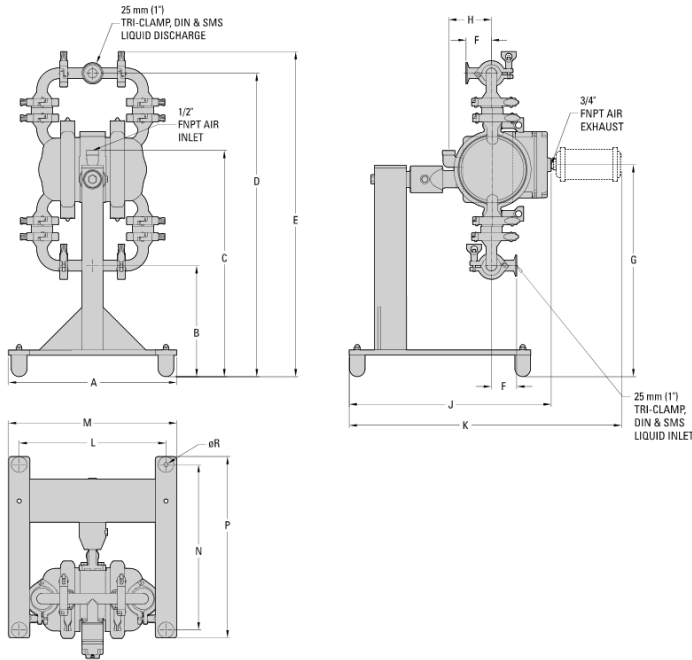

DIMENSIONS

ITEM	METRIC (mm)	STANDARD (inch)
A	401	15.8
B	264	10.4
C	538	21.2
D	721	28.4
E	775	30.5
F	61	2.4
G	505	19.9
H	104	4.1
J	480	18.9
K	648	25.5
L	351	13.8
M	401	15.8
N	394	15.5
P	432	17.0
R	ø10	ø.4

LW0436 REV. A

PS2 SANIFLO™ HYGIENIC™ SERIES – FIXED STAND

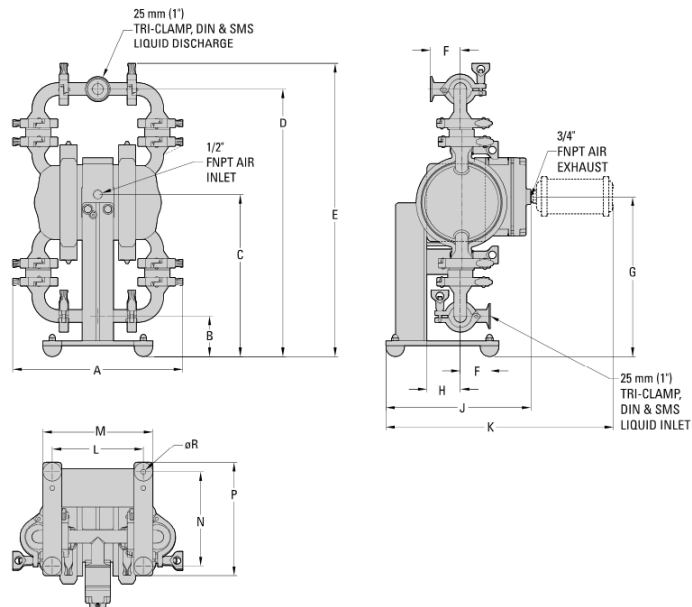

DIMENSIONS

ITEM	METRIC (mm)	STANDARD (inch)
A	343	13.5
B	81	3.2
C	327	12.9
D	540	21.3
E	591	23.3
F	61	2.4
G	322	12.7
H	69	2.7
J	292	11.5
K	460	18.1
L	185	7.3
M	224	8.8
N	191	7.5
P	229	9.0
R	ø10	ø0.4

LW0435 REV. A

SECTION 5

PERFORMANCE

**PS2 SANIFLO™
HYGIENIC™ SERIES
RUBBER-FITTED**

Ship Weight.....40 kg (80 lb)
Air Inlet.....1/2"
Inlet.....25 mm (1")
Outlet.....25 mm (1")
Suction Lift.....3.9 m Dry (13')
7.6 m Wet (25')
Disp. Per Stroke¹.....0.2 L (0.07 gal.)
Max. Flow Rate.....121 lpm (32 gpm)
Max. Size Solids.....6.4 mm (1/4")

¹Displacement per stroke was calculated at 4.8 bar (70 psig) air inlet pressure against a 2.1 bar (30 psig) head pressure.

Example: To pump 87 lpm (23 gpm) against a discharge head of 2.8 bar (40 psig) requires 6.9 bar (100 psig) and 68 Nm³/h (40 scfm) air consumption.

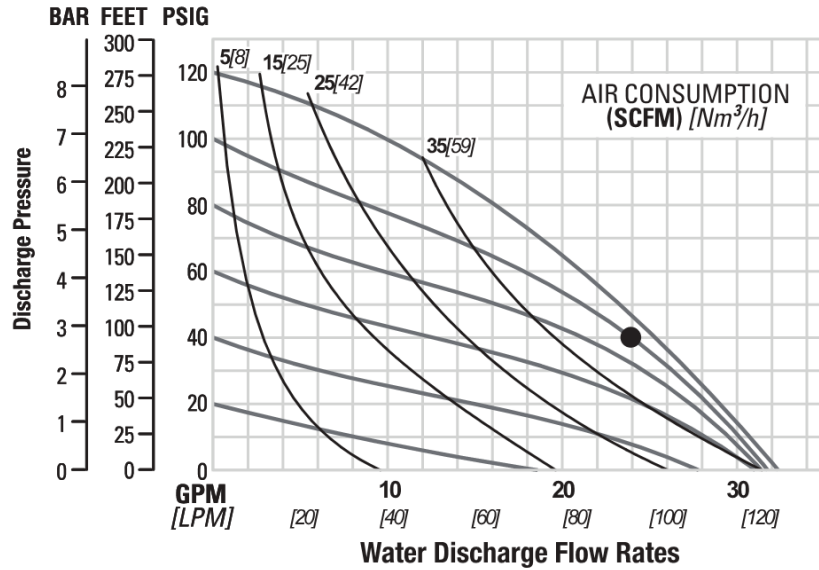

Flow rates indicated on chart were determined by pumping water. For optimum life and performance, pumps should be specified so that daily operation parameters will fall in the center of the pump's performance curve.

Caution: Do not exceed 8.6 bar (125 psig) air supply pressure.

**PS2 SANIFLO™
HYGIENIC™ SERIES
FULL-STROKE TPE
INTEGRAL PISTON
DIAPHRAGM-FITTED**

Ship Weight.....40 kg (80 lb)
Air Inlet.....1/2"
Inlet.....25 mm (1")
Outlet.....25 mm (1")
Suction Lift.....2.4 m Dry (8')
7.9 m Wet (26')
Disp. Per Stroke¹.....0.2 L (0.07 gal.)
Max. Flow Rate.....117 lpm (31 gpm)
Max. Size Solids.....6.4 mm (1/4")

¹Displacement per stroke was calculated at 4.8 bar (70 psig) air inlet pressure against a 2.1 bar (30 psig) head pressure.

Example: To pump 41 lpm (11 gpm) against a discharge head of 2.8 bar (40 psig) requires 4.1 bar (60 psig) and 35 Nm³/h (21 scfm) air consumption.

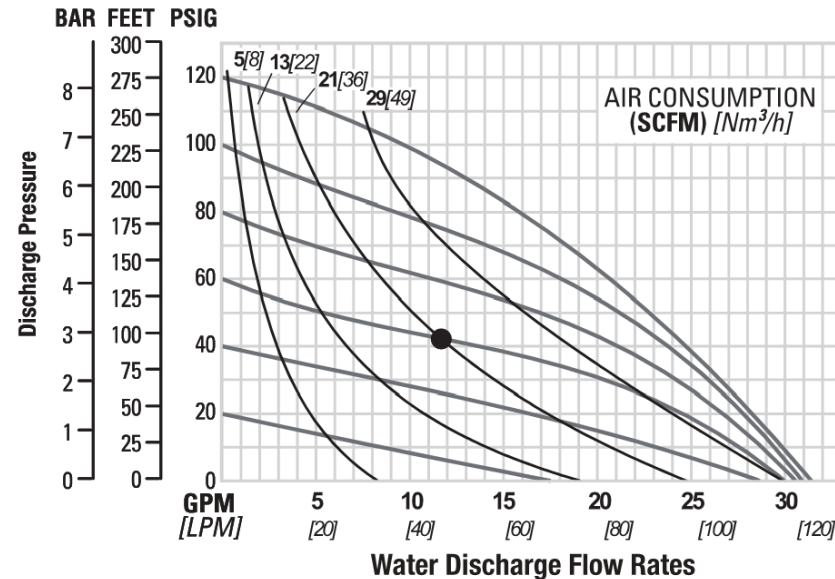

Flow rates indicated on chart were determined by pumping water. For optimum life and performance, pumps should be specified so that daily operation parameters will fall in the center of the pump's performance curve.

Caution: Do not exceed 8.6 bar (125 psig) air supply pressure.

PERFORMANCE

**PS2 SANIFLO™
HYGIENIC™ SERIES
FULL-STROKE
TPE-FITTED**

Ship Weight.....40 kg (80 lb)
Air Inlet.....1/2"
Inlet.....25 mm (1")
Outlet.....25 mm (1")
Suction Lift.....1.2 m Dry (4')
7.9 m Wet (26')
Disp. Per Stroke¹.....0.2 L (0.07 gal.)
Max. Flow Rate.....109 lpm (29 gpm)
Max. Size Solids.....6.4 mm (1/4")

¹Displacement per stroke was calculated at 4.8 bar (70 psig) air inlet pressure against a 2.1 bar (30 psig) head pressure.

Example: To pump 22 lpm (6 gpm) against a discharge head of 6.2 bar (90 psig) requires 6.9 bar (100 psig) and 35 Nm³/h (21 scfm) air consumption.

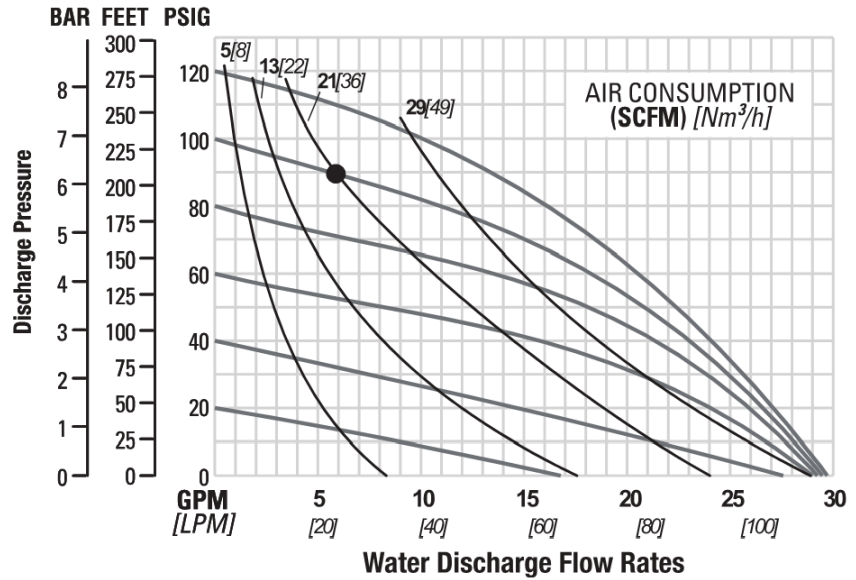

Flow rates indicated on chart were determined by pumping water. For optimum life and performance, pumps should be specified so that daily operation parameters will fall in the center of the pump's performance curve.

Caution: Do not exceed 8.6 bar (125 psig) air supply pressure.

**PS2 SANIFLO™
HYGIENIC™ SERIES
FULL-STROKE
PTFE-FITTED**

Ship Weight.....40 kg (80 lb)
Air Inlet.....1/2"
Inlet.....25 mm (1")
Outlet.....25 mm (1")
Suction Lift.....1.5 m Dry (10')
7.6 m Wet (25')
Disp. Per Stroke¹.....0.2 L (0.07 gal.)
Max. Flow Rate.....117 lpm (31 gpm)
Max. Size Solids.....6.4 mm (1/4")

¹Displacement per stroke was calculated at 4.8 bar (70 psig) air inlet pressure against a 2.1 bar (30 psig) head pressure.

Example: To pump 18 lpm (5 gpm) against a discharge head of 5.5 bar (80 psig) requires 6.9 bar (100 psig) and 36 Nm³/h (21 scfm) air consumption.

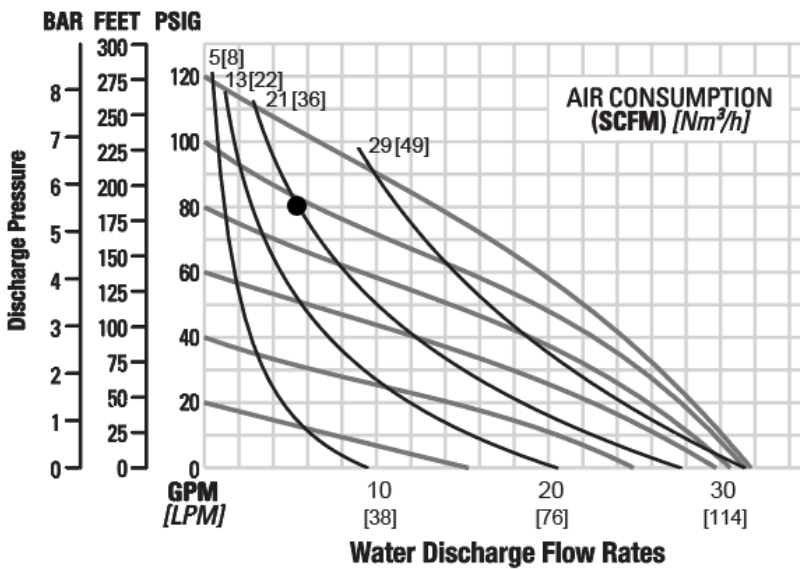

Flow rates indicated on chart were determined by pumping water. For optimum life and performance, pumps should be specified so that daily operation parameters will fall in the center of the pump's performance curve.

Caution: Do not exceed 8.6 bar (125 psig) air supply pressure.

SUCTION LIFT CAPABILITY

**PS2 SANIFLO™
 HYGIENIC™ SERIES
 SUCTION LIFT
 CAPABILITY**

Suction-lift curves are calibrated for pumps operating at 305 m (1,000') above sea level. This chart is meant to be a guide only. There are many variables that can affect your pump's operating characteristics. The number of intake and discharge elbows, viscosity of pumping fluid, elevation (atmospheric pressure) and pipe friction loss all affect the amount of suction lift your pump will attain.

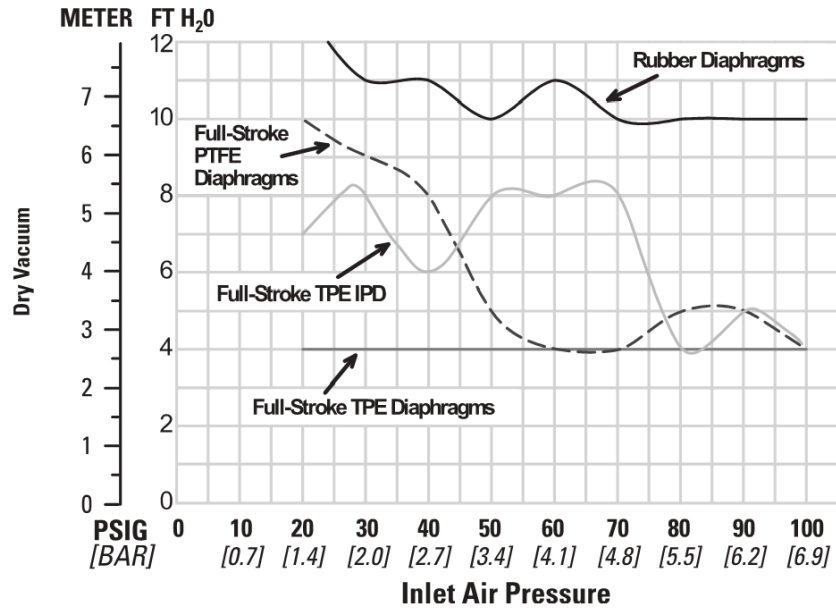

SECTION 6

SUGGESTED INSTALLATION, OPERATION, MAINTENANCE AND TROUBLESHOOTING

Wilden pumps are designed to meet the performance requirements of even the most demanding pumping applications. They have been designed and manufactured to the highest standards and are available in a variety of liquid path materials to meet your chemical resistance needs. Refer to "Performance" for an in-depth analysis of the performance characteristics of your pump. Wilden offers the widest variety of elastomer options in the industry to satisfy temperature, chemical compatibility, abrasion resistance and flex concerns.

The suction pipe size should be at least equal to or larger than the diameter size of the suction inlet on your Wilden pump. The suction hose must be a non-collapsible, reinforced type because these pumps are capable of pulling a high vacuum. Discharge piping should also be equal to or larger than the diameter of the pump discharge, which will help reduce friction losses.

CAUTION: All fittings and connections must be airtight. Otherwise, pump suction capability will be reduced or lost.

Months of careful planning, study and selection efforts can result in unsatisfactory pump performance if installation details are left to chance. You can avoid premature failure and long-term dissatisfaction by exercising reasonable care throughout the installation process.

Location

Noise, safety and other logistical factors usually dictate where equipment will be situated on the production floor. Multiple installations with conflicting requirements can result in congestion of utility areas, leaving few choices for additional pumps. Within the framework of these and other existing conditions, locate every pump in such a way that the following six key factors are balanced against each other to maximum advantage:

- **Access:** First, the location should be accessible. If it's easy to reach the pump, maintenance personnel will be able to perform routine inspections and adjustments more easily. If major repairs become necessary, ease of access can play a key role in speeding the repair process and reducing total downtime.
- **Air Supply:** Every pump location should have an air line large enough to supply the volume of air necessary to achieve the desired pumping rate. For best results, the pumps should use a 5µ (micron) air filter, needle valve and regulator. The use of an air filter before the pump will ensure that the majority of any pipeline contaminants will be eliminated.
- **Solenoid Operation:** When operation is controlled by a solenoid valve in the air line, three-way valves should be used. This valve allows trapped air between the valve and the pump to bleed off, which improves pump performance. You can estimate pumping volume by counting the number of strokes per minute, and then multiplying that figure by the displacement per stroke.
- **Muffler:** Using the standard Wilden muffler, sound levels are reduced below OSHA specifications. You can use other mufflers to reduce sound levels farther, but they usually reduce pump performance.
- **Elevation:** Selecting a site that is well within the pump's dynamic lift capability will assure that loss-of-prime issues will

be eliminated. In addition, pump efficiency can be adversely affected if proper attention is not given to site location.

- **Piping:** Final determination of the pump site should not be made until the piping challenges of each possible location have been evaluated. The impact of current and future installations should be considered ahead of time to make sure that inadvertent restrictions are not created for any remaining sites.

The best choice possible will be a site involving the shortest and straightest hook-up of suction and discharge piping. Unnecessary elbows, bends and fittings should be avoided. Pipe sizes should be selected to keep friction losses within practical limits. All piping should be supported independently of the pump. In addition, the piping should be aligned to avoid placing stress on the pump fittings.

Flexible hose can be installed to aid in absorbing the forces created by the natural reciprocating action of the pump. If the pump is to be bolted down to a solid location, a mounting pad placed between the pump and the foundation will assist in minimizing pump vibration. Flexible connections between the pump and rigid piping will also assist in minimizing pump vibration. If quick-closing valves are installed at any point in the discharge system, or if pulsation within a system becomes a problem, a surge suppressor (SD Equalizer) should be installed to protect the pump, piping and gauges from surges and water hammer.

If the pump is to be used in a self-priming application, make sure that all connections are airtight and that the suction lift is within the model's ability.

NOTE: Materials of construction and elastomer material have an effect on suction lift parameters. Please refer to "Performance" for specifics.

When pumps are installed in applications involving flooded suction or suction head pressures, a gate valve should be installed in the suction line to permit closing of the line for pump service.

Pumps in service with a positive suction head are most efficient when inlet pressure is limited to 0.5–0.7 bar (7–10 psig). Premature diaphragm failure may occur if positive suction is 0.7 bar (10 psig) and higher.

Single-Point Exhaust

Pro-Flo SHIFT pumps can be used for submersible applications when using the Pro-Flo SHIFT's single-point exhaust.

CAUTION: All Wilden pumps are capable of passing solids. Use a strainer on the pump intake to ensure that the pump's rated solids capacity is not exceeded.

CAUTION: Do not exceed 8.6 bar (125 psig) air supply pressure.

SUGGESTED INSTALLATION, OPERATION, MAINTENANCE AND TROUBLESHOOTING

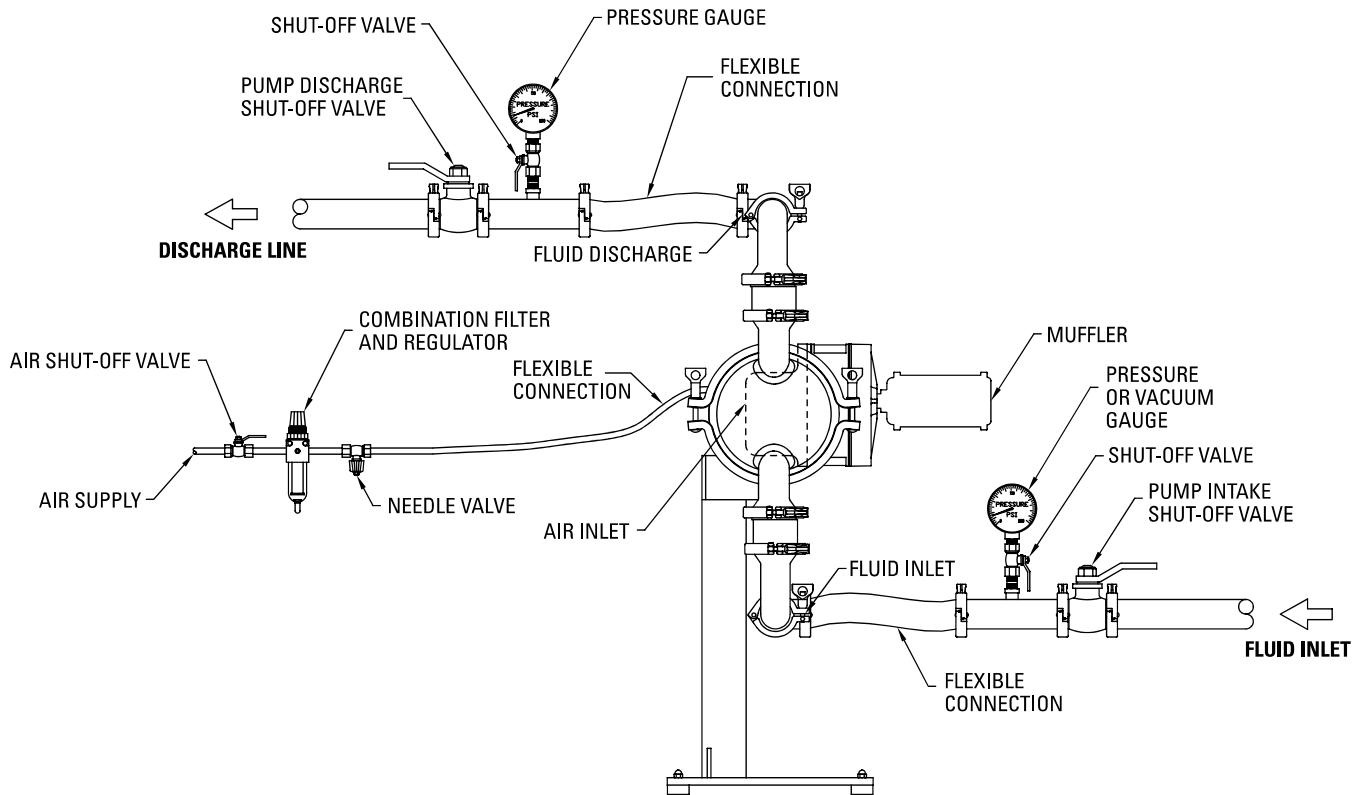

NOTE: In the event of a power failure, close the shut-off valve if you do not want the pump to restart when the power returns.

Air-Operated Pumps: To stop the pump from operating in an emergency, simply close the shut-off valve (user-supplied) installed in the air supply line. A properly functioning valve will stop the air supply to the pump, therefore stopping output. This shut-off valve should be located far enough away from the pumping equipment such that it can be reached safely in an emergency.

Operation

The Pro-Flo SHIFTPS2 pumps are pre-lubricated and do not require in-line lubrication. Additional lubrication will not damage the pump. However, if the pump is heavily lubricated by an external source, the pump's internal lubrication may be washed away. If the pump is then moved to a nonlubricated location, it may need to be disassembled and re-lubricated as described in "Disassembly/ Reassembly".

Pump discharge rate can be controlled by limiting the volume and/or pressure of the air supply to the pump. An air regulator is used to regulate air pressure. A needle valve is used to regulate volume. Pump discharge rate also can be controlled by throttling the pump discharge by partially closing a valve in the discharge line of the pump. This action increases friction loss, which reduces flow rate. (See "Performance") This is useful when the need exists

to control the pump from a remote location. When the pump discharge pressure equals or exceeds the air supply pressure, the pump will stop. No bypass or pressure relief valve is needed, and pump damage will not occur. The pump has reached a "deadhead" situation and can be restarted by reducing the fluid discharge pressure or increasing the air inlet pressure. Wilden Pro-Flo SHIFTPS2 pumps run solely on compressed air and do not generate heat. Therefore, your process fluid temperature will not be affected.

Maintenance and Inspections

Because each application is unique, maintenance schedules may be different for every pump. Frequency of use, line pressure, viscosity and abrasiveness of process fluid all affect the parts life of a Wilden pump. Periodic inspections have been found to offer the best means for preventing unscheduled pump downtime. Personnel familiar with the pump's construction and service should be informed of any abnormalities that are detected during operation.

SUGGESTED INSTALLATION, OPERATION, MAINTENANCE AND TROUBLESHOOTING

Troubleshooting

Pump will not run or runs slowly.

1. Remove plug from pilot spool exhaust.
2. Ensure that the air inlet pressure is at least 0.4 bar (5 psig) above startup pressure and that the differential pressure (the difference between air inlet and liquid discharge pressures) is not less than 0.7 bar (10 psig).
3. Check air inlet filter for debris (see "Suggested Installation, Operation, Maintenance and Troubleshooting").
4. Check for extreme air leakage (blow by) that would indicate worn seals/bores in the air valve, pilot spool and main shaft.
5. Disassemble the pump and check for obstructions in the air passageways or objects that would obstruct the movement of internal parts.
6. Check for sticking ball check valves.
 - a. If material being pumped is not compatible with pump elastomers, swelling may occur. Replace ball check valves and seals with proper elastomers.
 - b. Also, as the check valve balls wear out, they become smaller and can become stuck in the seats. In this case, replace balls and seats.
7. Check for any broken inner piston that would cause the air valve spool to be unable to shift.

Pump runs, but little or no product flows.

1. Check for pump cavitation. Slow pump speed down to allow thick material to flow into liquid chambers.
2. Verify that vacuum required to lift liquid is not greater than the vapor pressure of the material being pumped (cavitation).
3. Check for sticking ball check valves.
 - a. If material being pumped is not compatible with pump elastomers, swelling may occur. Replace ball check valves and seals with proper elastomers.
 - b. Also, as the check valve balls wear out, they become smaller and can become stuck in the seats. In this case, replace balls and seats.

Pump air valve freezes.

1. Check for excessive moisture in the compressed air.
 - a. Either install a dryer or a hot air generator for compressed air.
 - b. Alternatively, you may use coalescing filter to remove the water from the compressed air in some applications.

Air bubbles in pump discharge.

1. Check for a ruptured diaphragm.
2. Check tightness of outer pistons (see "Disassembly/Reassembly").
3. Check tightness of fasteners and integrity of O-rings and seals, especially at intake manifold.
4. Ensure pipe connections are airtight.

Product comes out air exhaust.

1. Check for a diaphragm rupture.
2. Check the tightness of the outer pistons to the shaft.

SECTION 7

DISASSEMBLY / REASSEMBLY

PUMP DISASSEMBLY

Tools Required:

- (2) Adjustable Wrenches
- Vise equipped with soft jaws (such as plywood, plastic or other suitable material)



CAUTION: Before attempting any maintenance or repair, disconnect the compressed air line to the pump and allow all air pressure to bleed from the pump. Disconnect all intake, discharge, and air lines. Drain the pump by turning it upside down and allowing any fluid to flow into a suitable container. Be aware of any hazardous effects of contact with your process fluid.



NOTE: Your specific pump model may vary from the configuration shown; however, pump disassembly procedure will be the same.



NOTE: Replace worn parts with genuine Wilden parts for reliable performance.

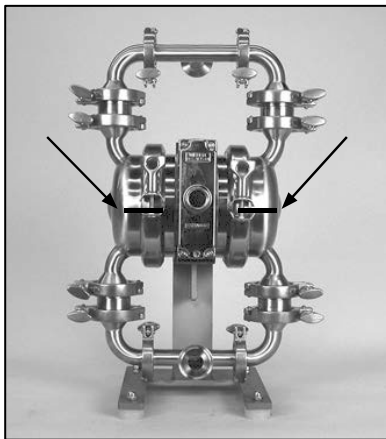

Step 1

Prior to assembly, alignment marks should be placed on the liquid chambers and air chambers to assist with proper alignment during reassembly.



Step 2

Loosen the wing nut and remove both discharge manifold clamp bands.

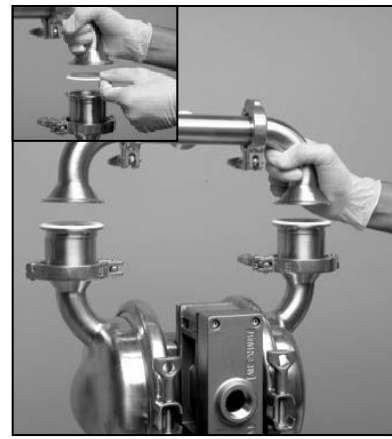

Step 3

Remove the discharge manifold and manifold gaskets.



Step 4

Next, remove the clamp bands that secure the ball valve housing to the liquid chamber.



Step 5

Next, remove the ball valve housing, valve ball and gasket.



Step 6

Loosen the wing nut and remove the inlet manifold clamp bands.

DISASSEMBLY / REASSEMBLY



Step 7

Next, remove the clamp bands that secure the ball valve housing to the liquid chamber.



Step 8

Next, remove the ball valve housing, valve ball and gasket from liquid chamber. To ensure proper alignment during reassembly of manifold/liquid chamber interface, turn off-set portion of valve housing to the left or to the right. This procedure works for the inlet manifold and discharge manifold connections.



Step 9

Now the large clamp bands can be removed. **NOTE:** Prior to assembly, alignment marks should be placed on the liquid chambers and air chambers to assist with proper alignment during reassembly.



Step 10a

Next, remove the liquid chamber from the center section assembly.



Step 10b

If your pump is fitted with an integral piston diaphragm (IPD), when you remove the liquid chamber you will notice that there is no outer piston.

DISASSEMBLY / REASSEMBLY



Step 11a

Using two (2) adjustable wrenches, turning in the opposite direction, loosen and remove one of the two outer pistons.



Step 11b

If your pump is fitted with an IPD, the procedure for removing the diaphragm is slightly different. In this case, simply grasp the diaphragm in two locations and turn in a counterclockwise direction.



Step 12a

After loosening and removing the outer piston, the remaining diaphragm assembly and shaft can be removed from the center section assembly.



Step 12b

If your pump is fitted with an IPD, the procedure for removing the diaphragm is the same.

DISASSEMBLY / REASSEMBLY

WIL-GARD™ DIAPHRAGM SENSOR REMOVAL



Step 1

After removing the inlet and discharge manifold assemblies, disconnect the Wil-Gard™ module from the sensor wires.



Step 2

Next, remove the large clamp bands and the liquid chamber on either side of the pump.



Step 3

The Wil-Gard™ sensor cables can be easily removed from the diaphragm assembly by simply pulling them from between the primary.

WIL-GARD™ DIAPHRAGM SENSOR INSTALLATION



Step 1

The Wil-Gard™ sensor wires must be installed between the primary diaphragm and the back-up diaphragm, on both sides of the pump, at the six o'clock position. They should be positioned approximately half the distance to the shaft from the edge of the diaphragm.



Step 2

Prior to installing the liquid chamber, and after positioning the Wil-Gard™ sensor cable between the primary and back-up diaphragms, run the sensor cable along the diaphragm bead but outside the pump. Now install the liquid chamber and large clamp band.



Step 3

When installing the liquid chamber and large clamp band, route the Wil-Gard™ sensor cable to the inside of the large clamp-band fastener. Next, reconnect the Wil-Gard™ module. **NOTE:** Use caution to ensure that the sensor wires are not damaged or pinched by the clamp band.

DISASSEMBLY / REASSEMBLY

SWIVEL PUMP STAND OPTION

For ease of maintenance and cleaning, Wilden offers an optional swivel pump stand. The swivel pump stand allows the pump to be drained by rotating the pump so that the fluid can flow out of the discharge and into a suitable container.

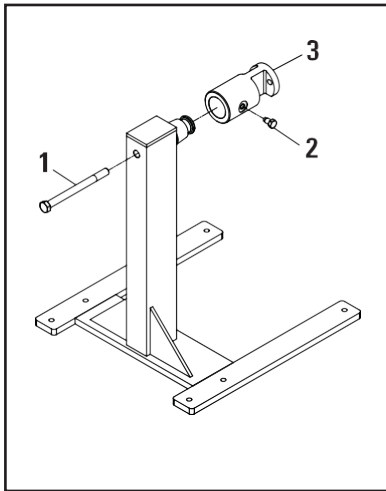

Draining Pump Contents

To drain the pump of its contents, first disconnect the inlet and discharge connections. Next loosen the anti-rotation bolt (item #1) by turning counterclockwise. Do not remove the bolt; only loosen the bolt two turns. After loosening the anti-rotation bolt, rotate pump 180°. This will allow the contents within the pump to flow out of the discharge and into a suitable container. After draining the pump, rotate the pump back to the upright position and tighten the anti-rotation bolt.

Removing Pump From Swivel Pump Stand

Saniflo™ Hygienic™ Series pumps are very heavy. It is recommended that the pump be disassembled while attached to the stand. If it is necessary to remove the pump from the stand while fully assembled, use a hoist or mechanical means to support the pump as it is removed from the stand. To remove your Saniflo™ Hygienic™ Series pump from the swivel pump stand, first loosen the anti-rotation bolt (item #1) by turning counterclockwise. Next, ensure the entire pump weight is supported by hoist and loosen the locking pin (item #2) by turning counterclockwise. This will allow the pump to be removed from the stand.



CAUTION: Removal of the locking pin (item #2) will allow the pump to fall from the stand, potentially causing injury to the operator or personnel in the immediate area. Never operate or store the pump without the locking pin (item #2) in place and properly torqued.



NOTE: The center block-to-bushing bolts (item #4) attach the center block mounting bushing (item #3) to the center block (not shown). These bolts do not need to be removed to remove the pump from the stand.



NOTE: Torque values are located in Section 7 of this manual.

DISASSEMBLY / REASSEMBLY

AIR VALVE / CENTER SECTION DISASSEMBLY

Tools Required:

- 3/16" Hex-Head Wrench
- 9/16" Wrench
- Snap-Ring Pliers
- O-Ring Pick



CAUTION: Before attempting any maintenance or repair, disconnect the compressed air line to the pump and allow all air pressure to bleed from the pump. Disconnect all intake, discharge, and air lines. Drain the pump by turning it upside down and allowing any fluid to flow into a suitable container. Be aware of any hazardous effects of contact with your process fluid.



NOTE: Replace worn parts with genuine Wilden parts for reliable performance.

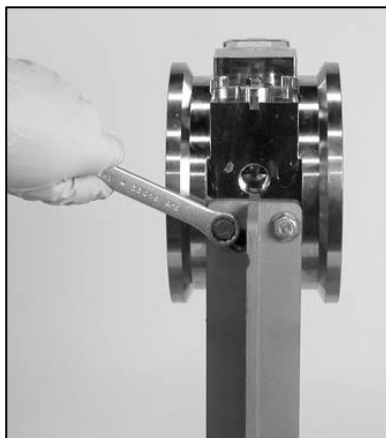

Step 1

Using a 9/16" wrench, loosen the bolts that connect the center section to the stand.

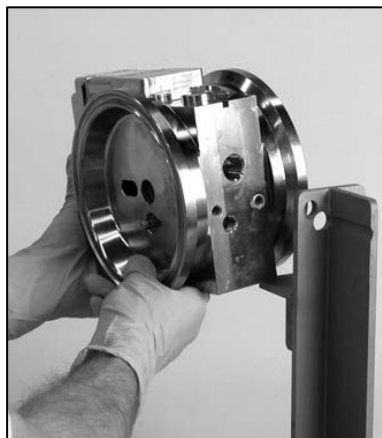

Step 2

Remove the center section from the stand.



Step 3

Using a 3/16" hex wrench, loosen air valve bolts.

CAUTION: With bolts removed, the center section is no longer attached to the stand and must be supported so that it does not fall from the stand.

DISASSEMBLY / REASSEMBLY

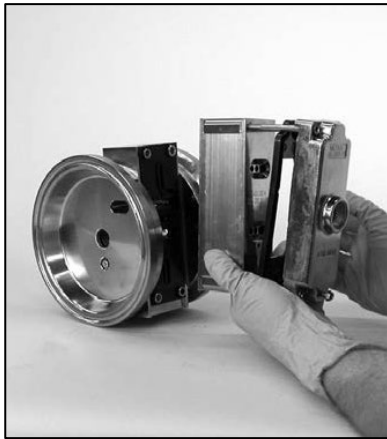

Step 4

Remove muffer plate and air valve bolts from air valve assembly exposing muffer gasket for inspection. Replace, if necessary.

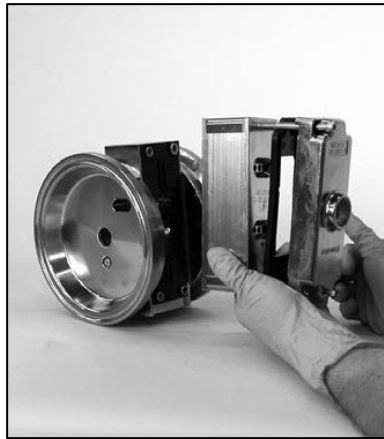

Step 5

Lift away air valve assembly and remove air valve gasket for inspection. Replace, if necessary.

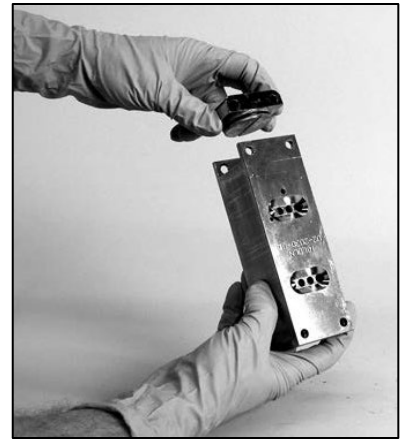

Step 6

Remove air valve end cap to expose air valve spool by simply lifting up on end cap once air valve bolts are removed.



Step 7

Remove the air valve spool from the air valve body by threading one air valve bolt into the end of the air valve spool and gently sliding the spool out of the air valve body. Inspect seals for signs of wear and replace entire assembly if necessary. Use caution when handling air valve spool to prevent damaging seals.

NOTE: Seals should not be removed from assembly. Seals are not sold separately.



Step 8

Remove pilot sleeve retaining snap ring on both sides of center section with snap-ring pliers.



Step 9

Remove pilot spool sleeve from center section.

DISASSEMBLY / REASSEMBLY

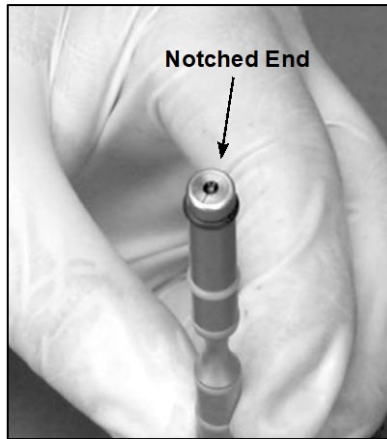

Step 10

Using an O-ring pick, gently remove the O-ring from the opposite side of the notched end on one side of the pilot spool. Gently remove the pilot spool from pilot spool sleeve and inspect for nicks, gouges and wear. Replace pilot sleeve or outer sleeve O-rings if necessary. During reassembly, never insert the pilot spool into the sleeve with the notched end first, this end incorporates the urethane O-ring and will be damaged as it slides over the ports cut in the sleeve.

NOTE: Seals should not be removed from pilot spool. Seals are not sold separately.

DISASSEMBLY / REASSEMBLY

SINGLE-POINT EXHAUST

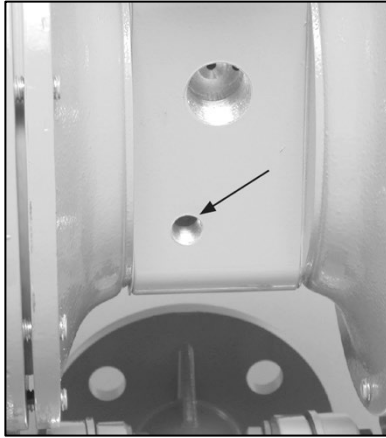

Step 1

Remove the pilot exhaust muffler in the pilot bleed port located at the front of the center block. Install 1/4" NPT pipe plug (00-7010-08) into the bleed port.

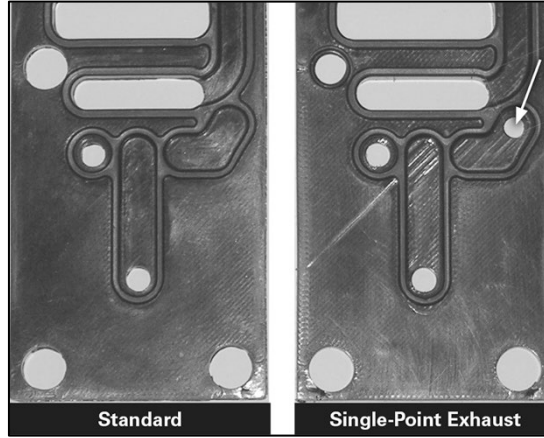

Step 2

Optional: Install a single-point exhaust gasket (04-2639-52). The single-point air valve gasket can be purchased as a spare part or included with the purchase of a new Pro-Flo SHIFT pump.

REASSEMBLY HINTS AND TIPS

Upon performing applicable maintenance to the air distribution system, the pump can now be reassembled. Please refer to the disassembly instructions for photos and parts placement.

To reassemble the pump, follow the disassembly instructions in reverse order. The air distribution system needs to be assembled first, then the diaphragms and finally the wetted path. The applicable torque specifications are on this page.

The following tips will assist in the assembly process:

- Lubricate the air valve bore, center section shaft and pilot spool bore with NLGI grade 2 white EP bearing grease or equivalent.
- Clean the inside of the center section shaft bore to ensure no damage is done to new shaft seals.
- A small amount of NLGI grade 2 white EP bearing grease can be applied to the muffler and air valve gaskets to lubricate gaskets during assembly.
- Make sure that the exhaust port on the muffler plate is centered between the two exhaust ports on the center section.
- Stainless bolts should be lubed to reduce the possibility of seizing during tightening.
- Use a mallet to tap lightly on the large clamp bands to seat the diaphragm before tightening

Maximum Torque Specifications	
Description	Torque
Air Valve	11.3 N·m (100 in-lb)
Dial Set Screw	11.3 N·m (100 in-lb)
Outer Piston	47.5 N·m (35 in-lb)
Center Block-to-Stand Bolt	44.7 N·m (33 ft-lb)
Center Block-to-Bushing Bolt	44.7 N·m (33 ft-lb)
Locking Pin	44.7 N·m (33 ft-lb)
Anti-Rotation Bolt	67.8 N·m (50 ft-lb)

NOTE: To ensure proper alignment during reassembly of manifold/liquid chamber interface, turn off-set portion of valve housing to the left or to the right. This procedure works for the inlet manifold and discharge manifold connections

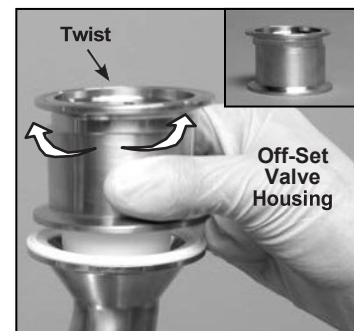

DISASSEMBLY / REASSEMBLY

SHAFT SEAL INSTALLATION

Pre-Installation

After all the old seals have been removed, the inside of the bushing should be cleaned to ensure no debris is left that may cause premature damage to the new seals.

Installation

1. To prevent damaging the inside surface of the new seal, wrap electrical tape around each leg of the needle-nose pliers. (Heat shrink tubing may also be used.)
2. With a new seal in hand, place the two legs of the needle-nose pliers inside the seal ring. (See Figure A.)
3. Open the pliers as wide as the seal diameter will allow, then with two fingers pull down on the top portion of the seal to form a kidney bean shape. (See Figure B.)
4. Lightly clamp the pliers together to hold the seal into the kidney shape. Be sure to pull the seal into as tight of a kidney shape as possible. This will allow the seal to travel down the bushing bore with greater ease.
5. With the seal clamped in the pliers, insert the seal into the bushing bore and position the bottom of the seal into the correct groove. When the bottom of the seal is seated in the groove, release the clamp pressure on the pliers. This will allow the seal to partially snap back to its original shape.
6. After removing the pliers, you will notice a slight bump in the seal shape. Before the seal can be resized properly, the bump in the seal should be removed as much as possible. This can be done with either a Phillips screwdriver or your finger. With the side of the screwdriver or your finger, apply light pressure to the peak of the bump. This pressure will cause the bump to be eliminated almost completely.
7. Lubricate the edge of the shaft with NLGI grade 2 white EP bearing grease.
8. Slowly insert the center shaft with a rotating motion. This will complete the resizing of the seal.
9. Repeat these steps for the remaining seals.

Tools

The following tools can be used to aid in the installation of the new seals:

- Needle-Nose Pliers
- Phillips Screwdriver
- Electrical Tape

Figure A

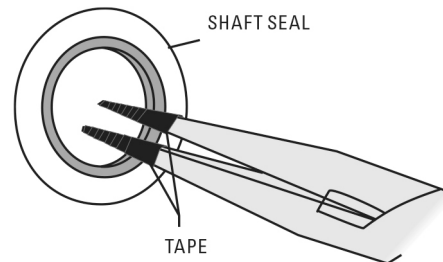
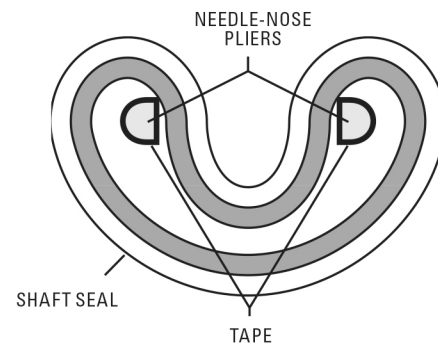

Figure B



SECTION 8

CLEAN-IN-PLACE (CIP)

The design of the Saniflo™ Hygienic™ Series pump allows for ease of cleaning. The Saniflo™ Hygienic™ Series pump can be cleaned in place without disassembly. Before any cleaning is attempted, ensure that the cleaning fluids are compatible with all wetted components.

For best cleaning results consider the following information prior to cleaning the Saniflo™ Hygienic™ Series pump.

- For best Clean-In-Place (CIP) results, the pump should be configured to 3-A configurations.
- Actual CIP effectiveness with pump user's product(s) and processes should be validated on location by the end user's quality assurance personnel to meet internal guidelines. Post cleaning swab test is one method to accomplish this.
- The pump user should establish periodic inspections with full tear down to verify that the CIP processes continue to be effective as first validated.
- Liquid inlet pressure to the pump should not be greater than 0.7 bar (10 psig). Premature diaphragm failure may occur if greater than 0.7 bar (10 psig) is applied. If the pump is to be subjected to greater than 0.7 bar (10 psig), an optional diaphragm balancing device is suggested to eliminate the possibility of the diaphragms being forced against the air chamber and subsequently causing premature diaphragm failure.

The following are some details to consider when cleaning the Saniflo™ Hygienic™ Series pump.

- Suggested flow rate for the PS2 HS pump is 3.4 m³/h (15 gpm). Typically, higher is better.
- Typical CIP temperature is 77°C to 82°C (170°F to 180°F).
- Typical chemicals include NaOH (sodium hydroxide) caustic for wash and light acid and sanitizers for rinse.

- Once an initial CIP regimen is established, it may need to be modified to accommodate specific process and product differences or requirements. The most common adjustments include:
 - Changing cleaning time (extended or reduced pre-rinse, wash, rinses)
 - Changing cleaning flow rate
- The cleaning variables are related so that a pump user may be able to reduce the cleaning time by increasing the flow rate or chemical mix.
- Chlorinated sanitizers are known to cause premature failure of stainless steel and should be avoided.
- Keep in mind, many CIP systems leave the pump filled with sanitizer and water and do not require draining.
- Wilden offers models with a swivel stand for manual draining when required. The swivel stand allows the pump to be rotated 180° allowing the contents within the pump to be easily drained into a suitable container.
- To drain a pump that is fitted with a non-swivel stand, the manifolds and liquid chambers must be removed if there is no automated CIP airblow system in place. With the use of an automated CIP airblow system, a pump fitted with a non-swivel stand can be cleaned in the same manner as a pump fitted with a swivel stand.
- An effective CIP system must have drain valves in the process line before and after the pump at the lowest points. The CIP system must be programmed to alternate between blowing air and opening the drain valves. This process must be repeated several times.

To Clean Pump

Activate the CIP system while slowly cycling the pump.

NOTE: A typical the CIP temperature limit is 90°C (195°F). If the CIP temperature is greater than 90°C (195°F), damage to the pump may occur.

SECTION 9

EXPLODED VIEW AND PARTS LIST

PS2 SANIFLO™ HYGIENIC™ SERIES

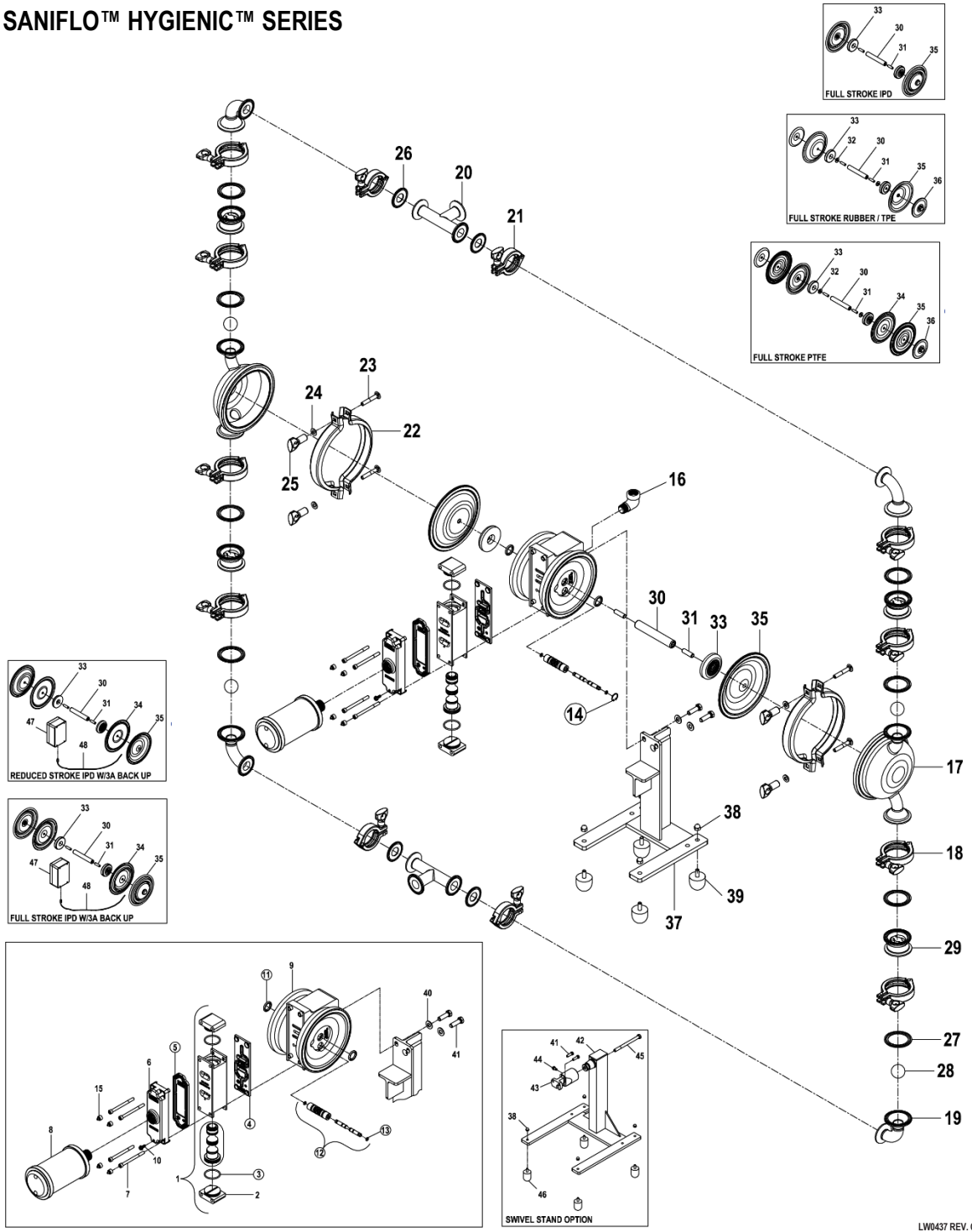

ALL CIRCLED PART IDENTIFIERS ARE INCLUDED IN REPAIR KITS

LW0437 REV. C

EXPLODED VIEW AND PARTS LIST

PS2 SANIFLO™ HYGIENIC™ SERIES

Item	Description	Model Description		XPS2 HS		XPS2 HS 3A	
		Qty		P/N		P/N	
Air Distribution Components							
1	Air Valve, Pro-Flo X™ Assembly ¹	1				02-2030-06	
2	End Cap, Pro-Flo X®	2				01-2335-06	
3	O-Ring, End Cap (-126) (Æ1.362 X Æ.103)	2				01-2395-52	
4	Gasket, Air Valve, Pro-Flo X®	1				02-2620-56	
5	Gasket, Muffler Plate, Pro-Flo X®	1				02-3502-56	
6	Muffler Plate, Pro-Flo X®	1				02-3185-06	
7	Screw, SHC, 1/4"-20 X 3"	4				01-6001-03	
8	Muffler	1				08-3510-06R	
9	Center Section Assembly, Pro-Flo SHIFIT ²	1				02-3139-06	
10	Screw, 10-32 X .50 Self-Tapping Grounding	1				04-6345-08	
11	Shaft Seal	2				02-3210-55-225	
12	Pilot Sleeve Assembly	1				02-3880-99	
13	Pilot Spool Retaining O-Ring (Æ.208 X Æ.070)	2				04-2650-49-700	
14	Retaining Ring	1				00-2650-03	
15	Plug, 1/4" SHCS (3-A)	4					02-7825-17
16	Elbow, Street, 90° 1/2" NPT ³	1				02-7843-03	
Wetted Path Components							
▲ 17	Chamber, Liquid CIP 1"	2				02-5002-10-385P	
18	Clamp Band, Assy, Medium	8				02-7200-03-85	
▲ 19	Elbow, 1"	4				02-5240-10-385P	
▲ 20	T-Section, 1"	2				02-5160-10-385P	
	T-Section, 1" DIN	2				02-5160-10-386P	
	T-Section, 1" SMS	2				02-5160-10-387P	
21	Clamp Band, Assy, Small	4				02-7100-03-85	
22	Clamp Band Assy, Large ³	2				02-7300-03-885	
23	Bolt, RHSN, 5/16"-18 X 2"	4				08-6050-03-500	
24	Washer, (.344 I.D. X .688 O.D. X .065 THK.)	4				02-6731-03	
25	Wing Nut, Medium Clamp	4				08-6661-10	
Gaskets/Valve Balls							
▲ 26	Gasket, 1"	4				*	
▲ 27	Gasket, 2"	8				*	
▲ 28	Valve Ball	4				*	
Check Valve Components							
▲ 29	Ball Cage, 1"	4				02-5350-10-385P	
Full Stroke Rubber/TPE/PTFE/FSIPD Components							
30	Shaft, P2 Pro-Flo™ (Non-PTFE)	1				02-3810-03	
31	Shaft Stud, 3/8"-16 X 1-1/4"	2				02-6150-03-85	
32	Spring, Disk	2				02-6802-08	
33	Piston, Inner, P2 Pro-Flo™ (Non-PTFE)	2				02-3701-01	
34	Diaphragm, Full Stroke PTFE, Back-Up	2				*	
	Diaphragm, Full Stroke IPD, Back-Up (3-A)	2					02-1061-55
▲ 35	Diaphragm, Primary	2				*	
	Diaphragm, Full Stroke PTFE, Primary	2				02-1040-55	
	Diaphragm, Full Stroke, IPD, Primary	2				*	
▲ 36	Piston, Outer, (Non-PTFE)	2				02-4550-10-385P	
Reduced Stroke SIPD Components							
30	Shaft, Pro-Flo™ (PTFE)	1				02-3840-03	
31	Shaft Stud, 3/8"-16 X 1-1/4"	2				02-6150-03-85	
33	Piston, Inner, P2 Pro-Flo™ (PTFE)	2				02-3751-01	
34	Diaphragm, Back-Up, IPD (3-A)	2					02-1060-55-85
▲ 35	Diaphragm, Integral Piston	2				02-1010-72-85	
Fixed Stand Components							
37	Stand, Pump, Assy. ⁴	1				02-7652-10-385	
38	Nut, Cap, 5/16"-18, Pump Stand	4				08-6600-03-72	
39	Pad, Pump Stand	4				08-7670-20	
40	Washer, (.406 I.D. X .812 O.D. X .065 Thk.)	2				04-6740-03	
41	Screw, HHC, 3/8"-16 X 1-1/4"	2				04-6190-03	
Swivel Stand Components							
42	Pump Stand, Swivel, Assy. ⁵ (3-A)	1				04-7655-03	
43	Bushing, Center Block Mounting	1				15-7667-03	
44	Locking Pin	1				08-7694-03	
45	Screw, HHC, 1/2"-13 X 6"	1				15-6143-03	
41	Screw, HHC, 3/8"-16 X 1-1/4"	2				04-6190-03	
38	Nut, Cap, 5/16"-18, Pump Stand	4				08-6600-03-72	
46	Pad, Pump Stand 2" (3-A)	4				08-7672-20	
Accessory Components							
47	Control Module, Wil-Gard II, 110 (3-A)	1				65-8001-99	
48	Sensor Cables, Wil-Gard II (3-A)	1				65-8020-99	

LW0438 Rev. D

* See elastomer chart - Section 10

▲ Product Contact Components

¹ Includes items 2 and 3.

² Includes items 11.

³ Large Clamp Band Assembly includes items 23, 24 and 25.

⁴ Pump Stand Assembly includes items 38, 39, 40 and 41.

⁵ Swivel Pump Stand Assembly includes items 38, 41, 43, 44, 45 and 46.

⁶ Required for all 1" Swivel Stand models.

All boldface items are primary wear parts.

EXPLODED VIEW AND PARTS LIST

PS2 SANIFLO™ HYGIENIC™ SERIES – 1935/2004/EC

Item	Description	Model Description	Qty	XPS2 HS	
				P/N	P/N
Air Distribution Components					
1	Air Valve, Pro-Flo X™ Assembly ¹		1		02-2030-06
2	End Cap, Pro-Flo X®		2		01-2335-06
3	O-Ring, End Cap (-126) (Æ1.362 X Æ.103)		2		01-2395-52
4	Gasket, Air Valve, Pro-Flo X®		1		02-2620-56
5	Gasket, Muffler Plate, Pro-Flo X®		1		02-3502-56
6	Muffler Plate, Pro-Flo X®		1		02-3185-06
7	Screw, SHC, 1/4"-20 X 3"		4		01-6001-03
8	Muffler		1		08-3510-06R
9	Center Section Assembly, Pro-Flo SHIF T ²		1		02-3139-06
10	Screw, 10-32 X .50 Self-Tapping Grounding		1		04-6345-08
11	Shaft Seal		2		02-3210-55-225
12	Pilot Sleeve Assembly		1		02-3880-99
13	Pilot Spool Retaining O-Ring (Æ.208 X Æ.070)		2		04-2650-49-700
14	Retaining Ring		1		00-2650-03
15	Plug, 1/4" SHCS (3-A)		4		02-7825-17
16	Elbow, Street, 90° 1/2" NPT ³		1		02-7843-03
Wetted Path Components					
▲ 17	Chamber, Liquid CIP 1"		2		02-5002-10-385P
18	Clamp Band, Assy, Medium		8		02-7200-03-85
▲ 19	Elbow, 1"		4		02-5240-10-385P
▲ 20	T-Section, 1"		2		02-5160-10-385P
	T-Section, 1" DIN		2	02-5160-10-386P	
	T-Section, 1" SMS		2	02-5160-10-387P	
21	Clamp Band, Assy, Small		4		02-7100-03-85
22	Clamp Band Assy, Large ³		2		02-7300-03-385
23	Bolt, RHSN, 5/16"-18 X 2"		4		08-6050-03-500
24	Washer, (.344 I.D. X .688 O.D. X .065 THK.)		4		02-6731-03
25	Wing Nut, Medium Clamp		4		08-6661-10
Gaskets/Valve Balls					
▲ 26	Gasket, 1", Pkg 4		1		*
▲ 27	Gasket, 2", Pkg 2		4		*
▲ 28	Valve Ball, Pkg 4		1		*
Check Valve Components					
▲ 29	Ball Cage, 1"		4		02-5350-10-385P
Full Stroke Rubber/TPE/PTFE/FSIPD Components					
30	Shaft, P2 Pro-Flo™ (Non-PTFE)		1		02-3810-03
31	Shaft Stud, 3/8"-16 X 1-1/4"		2		02-6150-03-85
32	Spring, Disk		2	02-6802-08	
33	Piston, Inner, P2 Pro-Flo™ (Non-PTFE)		2		02-3701-01
34	Diaphragm, Full Stroke PTFE, Back-Up, Pkg 2		1	*	
	Diaphragm, Full Stroke IPD, Back-Up (3-A), Pkg 2		1		02-1061-55E
▲ 35	Diaphragm, Primary, Pkg 2		1	*	
	Diaphragm, Full Stroke PTFE, Primary, Pkg 2		1	02-1040-55E	
	Diaphragm, Full Stroke, IPD, Primary, Pkg 2		1		02-1031-56E
▲ 36	Piston, Outer, (Non-PTFE)		2	02-4550-10-385P	
Reduced Stroke SIPD Components					
30	Shaft, Pro-Flo™ (PTFE)		1		02-3840-03
31	Shaft Stud, 3/8"-16 X 1-1/4"		2		02-6150-03-85
33	Piston, Inner, P2 Pro-Flo™ (PTFE)		2		02-3751-01
34	Diaphragm, Back-Up, IPD (3-A), Pkg 2		1		02-1060-55-85E
▲ 35	Diaphragm, Integral Piston, Pkg 2		1		02-1010-72-85E
Fixed Stand Components					
37	Stand, Pump, Assy. ⁴		1	02-7652-10-385	
38	Nut, Cap, 5/16"-18, Pump Stand		4		08-6600-03-72
39	Pad, Pump Stand		4	08-7670-20	
40	Washer, (.406 I.D. X .812 O.D. X .065 Thk.)		2	04-6740-03	
41	Screw, HHC, 3/8"-16 X 1-1/4"		2		04-6190-03
Swivel Stand Components					
42	Pump Stand, Swivel, Assy. ⁵ (3-A)		1		04-7655-03
43	Bushing, Center Block Mounting		1		15-7667-03
44	Locking Pin		1		08-7694-03
45	Screw, HHC, 1/2"-13 X 6"		1		15-6143-03
41	Screw, HHC, 3/8"-16 X 1-1/4"		2		04-6190-03
38	Nut, Cap, 5/16"-18, Pump Stand		4		08-6600-03-72
46	Pad, Pump Stand 2" (3-A)		4		08-7672-20
Accessory Components					
47	Control Module, Wil-Gard II, 110 (3-A)		1		65-8001-99
48	Sensor Cables, Wil-Gard II (3-A)		1		65-8020-99

LW0439 Rev. D

* See elastomer chart - Section 10

▲ Product Contact Components

¹ Includes items 2 and 3.

² Includes items 11.

³ Large Clamp Band Assembly includes items 23, 24 and 25.

⁴ Pump Stand Assembly includes items 38, 39, 40 and 41.

⁵ Swivel Pump Stand Assembly includes items 38, 41, 43, 44, 45 and 46.

⁶ Required for all 1" Swivel Stand models.

All boldface items are primary wear parts.

SECTION 10

ELASTOMER OPTIONS

PS2 SANIFLO™ HYGIENIC™ SERIES

MATERIAL	DIAPHRAGMS (2)	FULL-STROKE DIAPHRAGMS (2)	FULL-STROKE BACK-UP DIAPHRAGMS (2)	FULL-STROKE IPD DIAPHRAGMS (2)	FULL-STROKE IPD BACK-UP DIAPHRAGMS (2)	VALVE BALL (4)	GASKET, 1" (4)	GASKET, 2" (8)
FDA Buna-N							02-1320-69-85	08-1375-69
FDA EPDM	02-1010-74					02-1086-74	02-1320-74-85	08-1375-74
Saniflex™	02-1010-56		02-1065-56	02-1031-56		02-1085-56		
PTFE	02-1010-72-85	02-1040-55			02-1061-55	02-1085-55	02-1320-55-85	08-1375-55
FDA WIL-FLEX®	02-1010-57		02-1065-57	02-1031-57		02-1086-57		
FDA FKM							02-1320-68-85	02-1400-68-85

LW0438 Rev. D

PS2 SANIFLO™ HYGIENIC™ SERIES – 1935/2004/EC

Material	DIAPHRAGMS (2)	FULL-STROKE DIAPHRAGMS (2)	FULL-STROKE BACK UP DIAPHRAGMS (2)	FULL-STROKE IPD DIAPHRAGMS (2)	FULL-STROKE IPD BACK-UP DIAPHRAGMS (2)	VALVE BALL (4)	GASKET, 1" (4)	GASKET, 2" (4)
FDA Buna-N							02-1320-69-85E	08-1375-69E
FDA EPDM	02-1010-74E					02-1086-74E	02-1320-74-85E	08-1375-74E
Saniflex™	02-1010-56E		02-1065-56E	02-1031-56E		02-1085-56E		
PTFE	02-1010-72-85E	02-1040-55E			02-1061-55E	02-1085-55E	02-1320-55-85E	08-1375-55E
FDA FKM							02-1320-68-85E	02-1400-68-85E

LW0439 Rev. D

DECLARATION OF CONFORMITY

WILDEN®
DECLARATION OF CONFORMITY



PSG California LLC, 22069 Van Buren Street, Grand Terrace, CA 92313-5607 USA, certifies as the manufacturer that the Air-Operated Double Diaphragm pumps listed below comply with the following European Community Regulations:

(EC) 1935/2004 for Food Contact Materials

(EC) 2023/2006 Good Manufacturing Practice

(EU) 10/2011 on plastic materials and articles intended to come in contact with food

- **25 mm (1") Saniflo Hygienic™ HS Metal Pump:**
(XPS,PS)2/(SS,SZ)(SSS,NNN)(FBS,FES,FSL,FSS,LLEL,TEU,TSS,TSU)(FB,FE,FS,TF)(FB,FE,FV,TF)(0770-0789)E
- **38 mm – 76 mm (1-½"–3") Pro-Flo X Saniflo Hygienic™ HS Metal Pump:**
(PX,XPX)(4,8,15)(SS,SZ)(SSS,NNN)(BNU,EPU,FBS,FES,FSL,FSS,LLEL,TEU,TSS,TSU,ZSS)(FB,FE,FS,FV,SF,TF,TF,TF)(FB,FE,TF)(0770-0789)E
- **38 mm – 76 mm (1-½"–3") Pro-Flo Shift Saniflo Hygienic™ HS Metal Pump:**
(PS, XPS)(4,8,15)(SS,SZ)(SSS,NNN)(FBS,FES,FSL,FSS,LLEL,TSS,ZSS)(FB,FE,FS,FV,SF,TF,TF,TF)(FB,FE,TF)(0770-0789)E
- **76 mm (3") Saniflo HS High Pressure Advanced Metal Pump:**
H1500(SS,SZ)III(FSL,TSS)(TF,TF)(FE,FV,TF)0770E
- **13 mm (½") Pro-Flo & Pro-Flo X™ Saniflo FDA Metal Pump Models:**
(P,PX,XPX)1/(SS,SZ)(AAA,GGG,JJJ,LLL,PPP)(FSL,FSS,TEU,TSU)(FS,TF)(FS,TF)(0067,0070,0120)E
- **25 mm (1") Pro-Flo Saniflo FDA Metal Pump Models:**
P2/(SS,SZ)(LLL,PPP)(FBS,FES,FSL,FSS,LLEL,TEU,TSS,TSU)(FS,TF)(FS,TF)070E
- **38 mm (1-½") Pro-Flo & Pro-Flo X™ Saniflo FDA Metal Pump Models:**
(P,PX,XPX)4/(SS,SZ)(AAA,LLL,NNN,SSS)(BNU,EPU,FBS,FES,FSL,FSS,TEU,TSS,TSU)(FS,TF)(FS,TF)(0067,0070,0075,0120)E
- **51 mm (2") Pro-Flo & Pro-Flo X™ Saniflo FDA Metal Pump Models:**
(P,PX,XPX)8/(SS,SZ)(AAA,PPP,NNN,SSS)(BNU,EPU,FBS,FES,FSL,FSS,TEU,TSU,TSS)(FS,TF)(FS,TF)(0070,0075,0120)E
- **76 mm 3" Pro-Flo X™ Saniflo FDA Metal Pump Models:**
(PX,XPX)15/(SS,SZ)(AAA,NNN,SSS)(BNU,EPU,FSL,FSS,TEU,TSU,TSS)(FS,TF)(FS,TF)(0070,0075,0120)E
- **38 mm 1-½" Pro-Flo Shift™ Saniflo FDA Metal Pump Models:**
XPS4/(SS,SZ)(AAA,NNN,SSS)(FBS,FES,FSL,FSS,TSS,ZSS)(FS,TF)(FS,TF)(0067,0070,0775,0120)E
- **51 mm 2" Pro-Flo Shift™ Saniflo FDA Metal Pump Models:**
XPS8/(SS,SZ)(AAA,NNN,SSS)(FBS,FES,FSL,FSS,TSS,ZSS)(FS,TF)(FS,TF)(0070,0075,0120)E
- **76 mm 3" Pro-Flo Shift™ Saniflo FDA Metal Pump Models:**
XPS15/(SS,SZ)(AAA,NNN,SSS)(FSL,FSS,TSS,ZSS)(FS,SF,TF)(FE,FS,STF)(0070,0120,0341,0770)E

Materials used in equipment that are intended to contact food belong to the groups of materials listed in Annex 1 (EC) 1935/2004 (List of groups of materials and articles which may be covered by specific measures)

- 5) Rubbers 8) Metal and Alloy 10) Plastics

Compliance is subject to material and equipment storage, handling and usage recommended by Wilden in the engineering operation and maintenance manual and supplemental technical publications.

This declaration is based on the following information:

- Statements of raw material from suppliers
- Total Migration Analysis per (EU) 10/2011

Wilden will make available to the competent authorities appropriate documentation to demonstrate compliance

Approved By:

Chris Distaso
Director of Engineering
Date: October 10, 2019





PS2 Saniflo™ Hygienic™ Series

WILDEN®

NOTES



NOTES

WILDEN®

PSG
22069 Van Buren Street
Grand Terrace, CA 92313-5651 USA
P: +1 (909) 422 -1730
psgdover.com



Where Innovation Flows

PSG® reserves the right to modify the information and illustrations contained in this document without prior notice. This is a non-contractual document.