

# EOM

ENGINEERING OPERATION  
& MAINTENANCE

# T20 Clamped Metal Pump



Where Innovation Flows

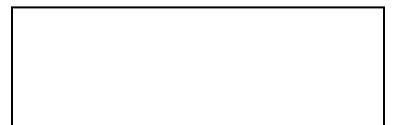

WIL-10280-E-04

## Contents

<b>Section 1: Precautions - Read First!</b> .....	<b>4</b>
<b>Section 2: Wilden Pump Designation System</b> .....	<b>5</b>
<b>Section 3: How It Works</b> .....	<b>6</b>
<b>Section 4: Dimensional Drawings</b> .....	<b>7</b>
<b>Section 5: Performance</b> .....	<b>8</b>
T20 Metal Food Grade/Polyurethane-Fitted.....	8
T20 Metal FKM®/PTFE-Fitted.....	8
T20 Metal Wil-Flex™/Polyurethane-Fitted.....	9
Suction-Lift Capability.....	10
<b>Section 6: Suggested Installation, Operation, Maintenance and Troubleshooting</b> .....	<b>11</b>
<b>Section 7: Disassembly / Reassembly</b> .....	<b>14</b>
Pump Disassembly.....	14
Inlet Housing Disassembly.....	15
Center Section Housing Disassembly.....	16
Discharge Housing Disassembly.....	21
Pump Body Disassembly.....	22
Air Valve Disassembly.....	23
<b>Section 8: Exploded View and Parts List</b> .....	<b>27</b>
T20 Original™ Metal.....	27
<b>Section 9: Elastomer Options</b> .....	<b>29</b>

**Copyright**

Copyright 2018 PSG®, a Dover Company. All rights reserved.

PSG reserves the right to modify the information and illustrations in this document without prior notice. The product described in this document is furnished under a license agreement or nondisclosure agreement. No part of this document may be reproduced, stored in a retrieval system, or transmitted in any form or any means electronic or mechanical, including photocopying and recording, without the written permission of PSG, a Dover Company, except as described by the terms of those agreements.

This is a non-contractual document. 01-2019.

**Trademarks**

PSG and the PSG logo are registered trademarks of PSG. Wilden® is a registered trademark of PSG California LLC. Pro-Flo® SHIFT, Pro-Flo®, and Wil-Flex® are registered trademarks of PSG California LLC. Chem-Fuse™, Pure-Fuse™, Saniflex™, and Bunalast™ are trademarks of PSG California LLC.

All trademarks, names, logos and service marks (collectively "trademarks") in this document are registered and unregistered trademarks of their respective owners. Nothing contained in this document should be construed as granting any license or right to use any trademark without the prior written permission of the trademark owner.

**Warranty**

Each and every product manufactured by Wilden is built to meet the highest standards of quality. Every pump is functionally tested to insure integrity of operation. Wilden warrants that pumps, accessories and parts manufactured or supplied by it to be free from defects in material and workmanship for a period of five (5) years from date of installation or six (6) years from date of manufacture, whichever comes first.

For more information, and to register your Wilden pump for warranty, please visit <https://www.psgdover.com/wilden/support/warranty-registration>.

**Certifications**

**Section 1**

**Precautions - Read First!**

 **TEMPERATURE LIMITS:**

Neoprene	0°F to 200°F	-17.8°C to 93.3°C
Buna-N	+10°F to +180°F	-12.2°C to 82.2°C
EPDM	-60°F to 280°F	-51.1°C to 137.8°C
FKM®	-40°F to +350°F	-40°C to 176.7°C
Wil-Flex®	-40°F to +225°F	-40°C to 107.2°C
Polyurethane	10°F to 150°F	12.2°C to 65.6°C
Saniflex™	-20°F to 220°F	-28.9°C to 104.4°C
PTFE	40°F to +220°F	4.4°C to 104.4°C
Fluoro-Seal™	-40°F to +450°F	-40°C to 232°C

**NOTE:** Not all materials are available for all models. See "Wilden Pump Designation System" on page 5 for material options for your pump.

 **WARNING:** Possible explosion can result from Halogenated Hydrocarbon solvents when used in pressurized fluid systems having aluminum or galvanized wetted parts.

 **CAUTION:** Do not exceed 125 psig air supply pressure. (50 psig on UL models.).

 **CAUTION:** Always wear safety glasses when operating pump. When diaphragm rupture occurs, material being pumped may be forced out air exhaust.

 **NOTE:** Pump must be lubricated. Wilden suggests an arctic 5 weight oil (ISO grade 15).

 **WARNING:** Prevention of static sparking — If static sparking occurs, fire or explosion could result. Pump, valves, and containers must be grounded when handling flammable fluids and whenever discharge of static electricity is a hazard.

 **CAUTION:** Do not exceed 125 psig air supply pressure. Blow out air line for 10 to 20 seconds before attaching to pump to make sure all pipe line debris is clear. Always use an in-line filter.

 **CAUTION:** Before any maintenance or repair is attempted, the compressed air line to the pump should be disconnected and all air pressure allowed to bleed from pump. Disconnect all intake, discharge and air lines.

 **NOTE:** Before starting disassembly, mark a line from each liquid chamber to its corresponding air chamber, as well as a line from the liquid chamber to its corresponding discharge elbow and ball pot. These lines will assist in proper alignment during reassembly.

 **CAUTION:** When removing the end cap using compressed air, the air valve end cap may come out with considerable force. Hand protection such as a padded glove or a rag should be used to capture the end cap.

 **NOTE:** All non-lube-free air-operated pumps must be lubricated. Wilden suggests an arctic weight oil (ISO grade 15).

 **CAUTION:** When choosing pump materials, be sure to check the temperature limits for all wetted components. Example: FKM® has a maximum limit of 176.7°C (350°F) but polypropylene has a maximum limit of only 79°C (175°F).

 **WARNING:** Tighten all clamp bands prior to installation. Fixing bolts may loosen during transportation.

 **CAUTION:** Verify the chemical compatibility of the process and cleaning fluid to the pump's component materials in the Chemical Resistance Guide (see E4).

 **CAUTION:** Only explosion proof (NEMA 7) solenoid valves should be used in areas where explosion proof equipment is required

 **CAUTION:** Maximum temperature limits are based upon mechanical stress only. Certain chemicals will significantly reduce maximum safe operating temperatures. Consult engineering guide for chemical compatibility and temperature limits.

 **CAUTION:** When choosing pump materials, be sure to check the temperature limits for all wetted components. Example: FKM has a maximum limit of 176.7°C (350°F) but polypropylene has a maximum limit of only 79°C (175°F).



**Section 3**

**HOW IT WORKS — PUMP**

The Wilden diaphragm pump is an air-operated, positive displacement, self-priming pump. These drawings show the flow pattern through the pump upon its initial stroke. It is assumed the pump has no fluid in it prior to its initial stroke.

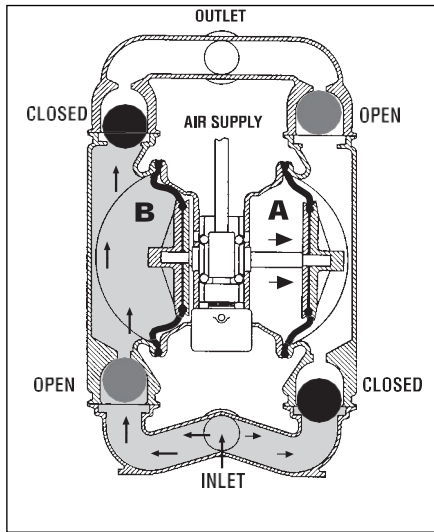

**FIGURE 1** The air valve directs pressurized air to the back side of diaphragm A. The compressed air is applied directly to the liquid column separated by elastomeric diaphragms. The diaphragm acts as a separation membrane between the compressed air and liquid, balancing the load and removing mechanical stress from the diaphragm. The compressed air moves the diaphragm away from the center block of the pump. The opposite diaphragm is pulled in by the shaft connected to the pressurized diaphragm. Diaphragm B is on its suction stroke; air behind the diaphragm has been forced out to the atmosphere through the exhaust port of the pump. The movement of diaphragm B toward the center block of the pump creates a vacuum within chamber B. Atmospheric pressure forces fluid into the inlet manifold forcing the inlet valve ball off its seat. Liquid is free to move past the inlet valve ball and fill the liquid chamber (see shaded area).

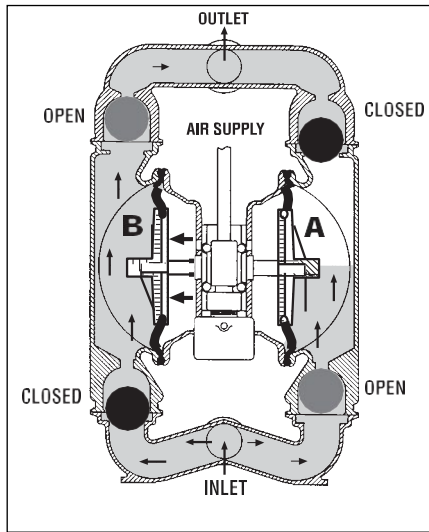

**FIGURE 2** When the pressurized diaphragm, diaphragm A, reaches the limit of its discharge stroke, the air valve redirects pressurized air to the back side of diaphragm B. The pressurized air forces diaphragm B away from the center block while pulling diaphragm A to the center block. Diaphragm B is now on its discharge stroke. Diaphragm B forces the inlet valve ball onto its seat due to the hydraulic forces developed in the liquid chamber and manifold of the pump. These same hydraulic forces lift the discharge valve ball off its seat, forcing fluid to flow through the pump discharge. The movement of diaphragm A toward the center block of the pump creates a vacuum within liquid chamber A. Atmospheric pressure forces fluid into the inlet manifold of the pump. The inlet valve ball is forced off its seat allowing the fluid being pumped to fill the liquid chamber.

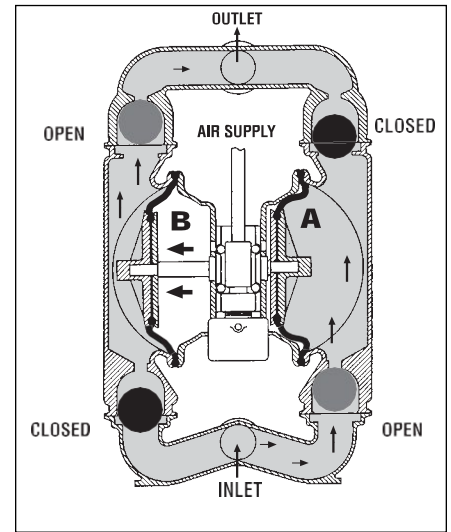
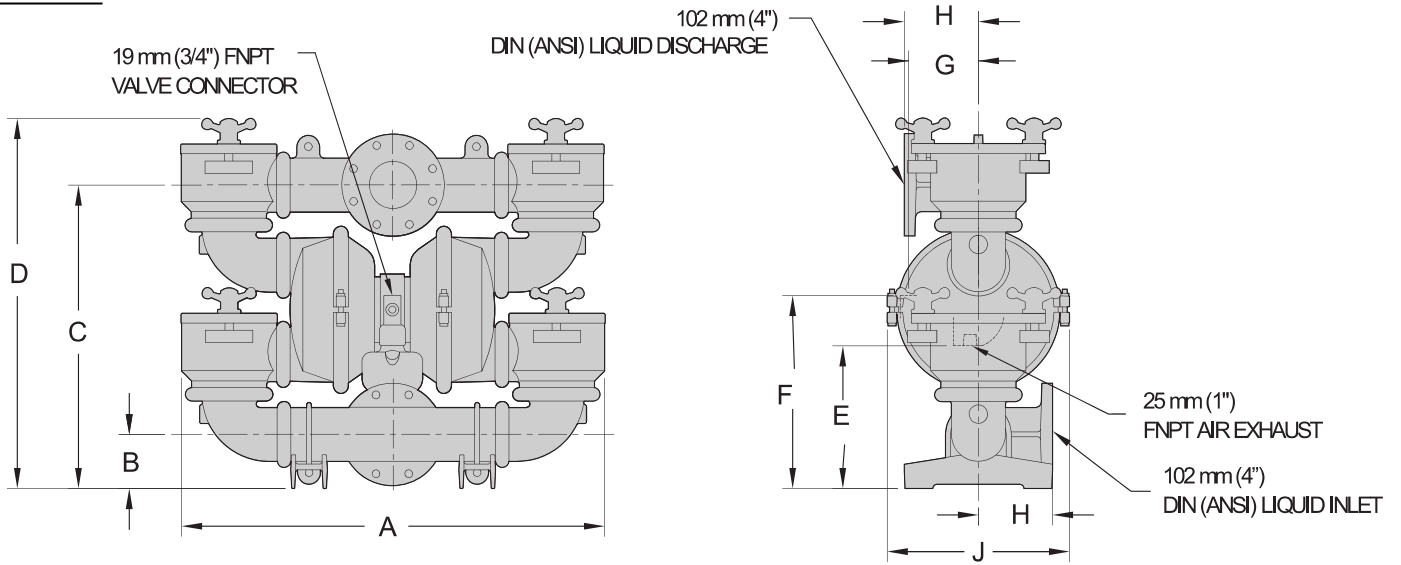

**FIGURE 3** At completion of the stroke, the air valve again redirects air to the back side of diaphragm A, which starts diaphragm B on its exhaust stroke. As the pump reaches its original starting point, each diaphragm has gone through one exhaust and one discharge stroke. This constitutes one complete pumping cycle. The pump may take several cycles to completely prime depending on the conditions of the application.

**Section 4**

**DIMENSIONAL DRAWING**

**T20 Metal**



**DIMENSIONS**

ITEM	METRIC (mm)	STANDARD (inch)
A	950	37.4
B	119	4.7
C	680	26.8
D	826	32.5
E	330	13.0
F	439	17.3
G	155	6.1
H	168	6.6
J	424	16.7
K	333	13.1
L	279	11.0
M	455	17.9
N	376	14.8
P	15 DIA.	.6 DIA.
R	231	9.1
S	191	7.5
T	18 DIA.	.7 DIA.

Rev. B





**PERFORMANCE**

**T20 METAL  
Wil-Flex™  
Polyurethane-Fitted**

Height .....	826 mm (32.5")
Width .....	940 mm (37.0")
Depth .....	330 mm (13.0")
Est. Ship Weight ..Cast Iron	231 kg (500 lbs)
Air Inlet.....	19 mm (3/4")
Inlet.....	102 mm (4")
Outlet .....	102 mm (4")
Suction Lift .....	12' Dry (3.66 m) 30' Wet (9.14 m)
Disp. Per Stroke <sup>1</sup> .....	1.22 gal. (4.62 l)
Max. Flow Rate.....	1041 lpm (275 gpm)
Max. Size Solids.....	35 mm (1-3/8")

<sup>1</sup>Displacement per stroke was calculated at 70 psig air inlet pressure against a 30 psig head pressure.

**Example:** To pump 160 gpm against a discharge head of 30 psig requires 60 psig and 90 scfm air consumption. (See dot on curve.)

**T20 Metal Wil-Flex™/Polyurethane-Fitted**

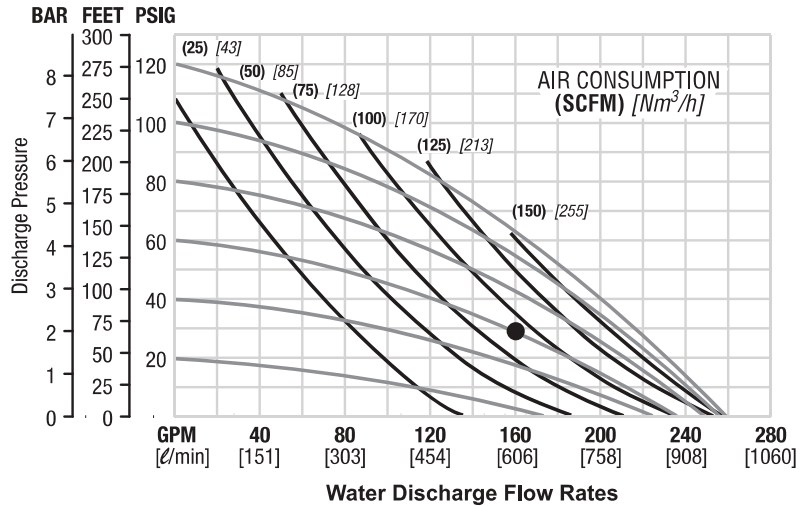

*Volumes indicated on chart were determined by actually pumping water.  
For optimum life and performance, pumps should be specified so that daily operation parameters will fall in the center of the pump performance curve.*

## Section 6

# Suggested Installation, Operation, Maintenance and Troubleshooting

The Model T20 has a 102 mm (4") inlet and 102 mm (4") outlet and is designed for flows to 1041 lpm (275 gpm). The **T20** pump is manufactured with wetted parts of Cast Iron. The center block of the **T20** is constructed of die cast aluminum. A variety of diaphragms, valve balls, and o-rings are available to satisfy temperature, chemical compatibility, abrasion and flex concerns.

The suction pipe size should be at least 102 mm (4") diameter or larger if highly viscous material is being pumped. The suction hose must be non-collapsible, reinforced type as the T20 is capable of pulling a high vacuum. Discharge piping should be at least 102 mm (4"); larger diameter can be used to reduce friction losses. It is critical that all fittings and connections are airtight or a reduction or loss of pump suction capability will result.

### Installation

Months of careful planning, study, and selection efforts can result in unsatisfactory pump performance if installation details are left to chance. Premature failure and long term dissatisfaction can be avoided if reasonable care is exercised throughout the installation process.

### Location

Noise, safety, and other logistical factors usually dictate that "utility" equipment be situated away from the production floor. Multiple installations with conflicting requirements can result in congestion of utility areas, leaving few choices for siting of additional pumps.

Within the framework of these and other existing conditions, every pump should be located in such a way that four key factors are balanced against each other to maximum advantage.

- **Access:** First of all, the location should be accessible. If it's easy to reach the pump, maintenance personnel will have an easier time carrying out routine inspections and adjustments. Should major repairs become necessary, ease of access can play a key role in speeding the repair process and reducing total downtime.

- **Air Supply:** Every pump location should have an air line large enough to supply the volume of air necessary to achieve the desired pumping rate (see pump performance chart). Use air pressure up to a maximum of 125 psig depending upon pumping requirements.

For best results, the pumps should use an air filter, regulator, and lubricator system. The use of an air filter before the pump will ensure that the majority of any pipeline contaminants will be eliminated. The use of a lubricant, suitable for the application, helps perform a number of functions. Lubricants reduce friction to minimize required shifting forces and reduce wear. Lubricants provide a protective coating against some forms of corrosion and contaminants. **Wilden suggests an oil with arctic characteristics (ISO 15-5Wt.) This oil is chemically compatible with the center block Glyd™ rings and has a low pour point to guard against problems associated with low temperatures.** The amount of lubrication required is directly related to the amount of oil introduced from the factory air system. We therefore suggest that the lowest setting on the lubricator be utilized and then increased as necessary.

Pump discharge rate can be controlled by limiting the volume and/or pressure of the air supply to the pump. The use of a needle valve installed at the air inlet to the pump is suggested for this purpose. Pump discharge rate can also be controlled by installing a valve in the discharge line of the pump when the need to control the pump from a remote location exists. When the pump discharge pressure equals or exceeds the air supply pressure, the pump will stop; no bypass or pressure relief valve is needed,

and pump damage will not occur. When operation is controlled by a solenoid valve in the air line, a three-way valve should be used. Pumping volume can be set by counting the number of strokes per minute. A muffler installed on the the pump's air exhaust will give quiet exhaust. Sound levels are reduced below OSHA specifications using a Wilden muffler

- **Elevation** Selecting a site that is well within the pump's suction lift capability will assure that loss-of-prime troubles will be eliminated. In addition, pump efficiency can be adversely affected if proper attention is not given to elevation (see pump performance chart).

- **Piping:** Final determination of the pump site should not be made until the piping problems of each possible location have been evaluated. The impact of current and future installations should be considered ahead of time to make sure that inadvertent restrictions are not created for any remaining sites. The best choice possible will be a site involving the shortest and the straightest hook-up of suction and discharge piping. Unnecessary elbows, bends, and fittings should be avoided. Pipe sizes should be selected so as to keep friction losses within practical limits. All piping should be supported independently of the pump. In addition, it should line up without placing stress on the pump fittings.

Expansion joints can be installed to aid in absorbing the forces created by the natural reciprocating action of the pump. If the pump is to be bolted down to a solid foundation, a mounting pad placed between the pump and foundation will assist in minimizing pump vibration. Flexible connections between the pump and rigid piping will also assist in minimizing pump vibration. If quick-closing valves are installed at any point in the discharge system, or if pulsation within a system becomes a problem, a surge suppressor should be installed to protect the pump, piping and gauges from surges and water hammer.

When pumps are installed in applications involving flooded suction or suction head pressures, a gate valve should be installed in the suction line to permit closing of the line for pump service.

The T20 can be used in submersible applications only when both wetted and non-wetted portions are compatible with the material being pumped. If the pump is to be used in a submersible application, a hose should be attached to the pump's air exhaust and the exhaust air piped above the liquid level.

If the pump is to be used in a self-priming application, be sure that all connections are airtight and that the suction lift is within the pump's ability. Note: Materials of construction and elastomer material have an effect on suction lift parameters. See pump performance data.

Pumps in service with a positive suction head are most efficient when inlet pressure is limited to 0.5–0.7 bar (7–10 psig). Premature diaphragm failure may occur if positive suction is 0.8 bar (11 psig) and higher.

THE MODEL T20 WILL PASS 35 mm (1-3/8") SOLIDS. WHENEVER THE POSSIBILITY EXISTS THAT LARGER SOLID OBJECTS MAY BE SUCKED INTO THE PUMP, A STRAINER SHOULD BE USED ON THE SUCTION LINE.

**CAUTION: DO NOT EXCEED 8.6 BAR (125 PSIG) AIR SUPPLY PRESSURE.**

**BLOW OUT AIR LINE FOR 10 TO 20 SECONDS BEFORE ATTACHING TO PUMP TO MAKE SURE ALL PIPE LINE DEBRIS IS CLEAR. ALWAYS USE AN IN-LINE FILTER.**

**PUMPS SHOULD BE THOROUGHLY FLUSHED WITH WATER BEFORE INSTALLING INTO PROCESS LINES. FDA AND USDA APPROVED PUMPS SHOULD BE CLEANED AND/OR SANITIZED BEFORE BEING USED ON EDIBLE PRODUCTS.**

## Suggested Installation, Operation, Maintenance and Troubleshooting

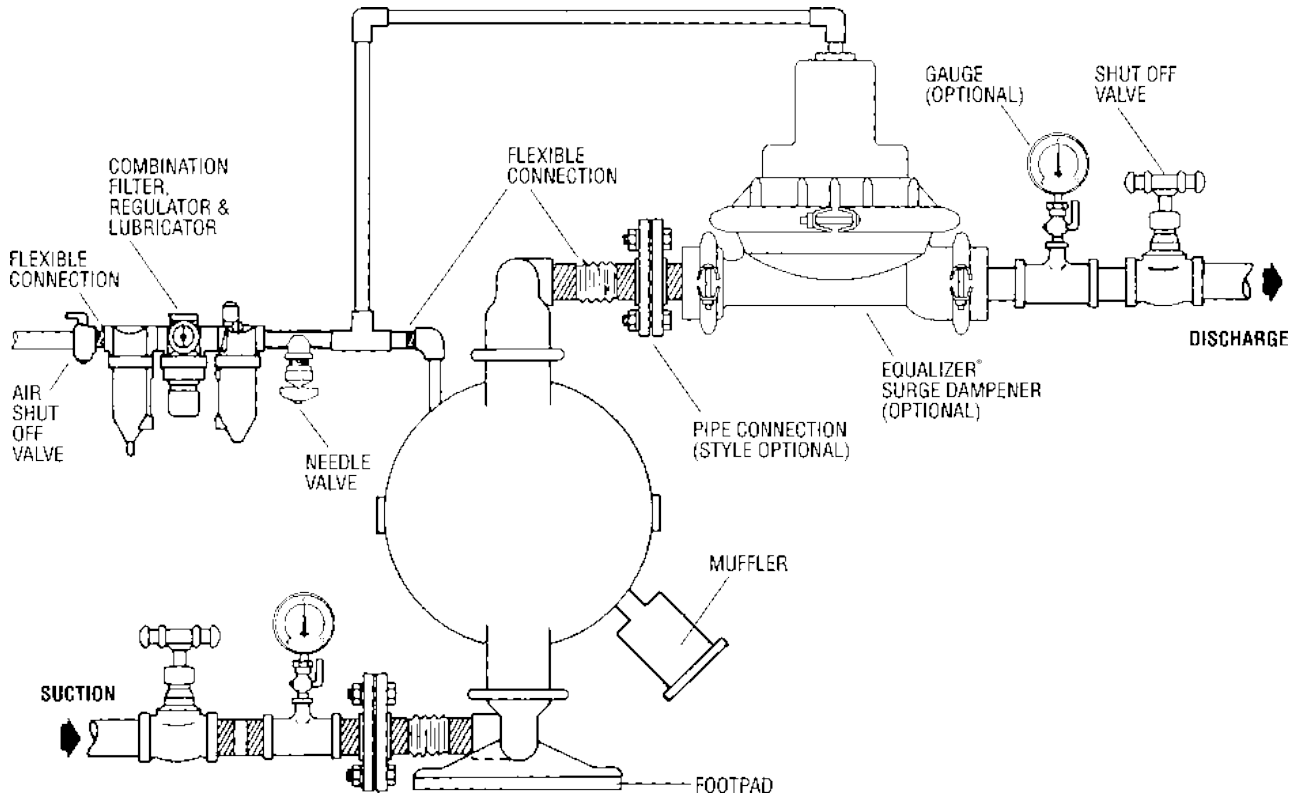

**⚠ NOTE:** In the event of a power failure, the shutoff valve should be closed, if the restarting of the pump is not desirable once power is regained.

**Air-Operated Pumps:** To stop the pump from operating in an emergency situation, simply close the “shut-off” valve (user supplied) installed in the air supply line. A properly functioning valve will stop the air supply to the pump, therefore stopping output. This shut-off valve should be located far enough away from the pumping equipment such that it can be reached safely in an emergency situation.

### Operation

Pump discharge rate can be controlled by limiting the volume and/or pressure of the air supply to the pump (preferred method). A regulator is used to regulate air pressure. A needle valve is used to regulate air volume. Pump discharge rate can also be controlled by throttling the pump discharge by partially closing a valve in the discharge line of the pump. This action increases friction loss which reduces flow rate. This is useful when the need exists to control the pump from a remote location. When the pump discharge pressure equals or exceeds the air supply pressure, the pump will stop; no bypass or pressure relief valve is needed, and pump damage will not occur. The pump has reached a “deadhead” situation and can be restarted by reducing the fluid discharge pressure or increasing the air inlet pressure. The Wilden T15 pump runs solely on compressed air and does not generate heat, therefore your process fluid temperature will not be affected.

### Maintenance and Inspections

Since each application is unique, maintenance schedules may be different for every pump. Frequency of use, line pressure, viscosity and abrasiveness of process fluid all affect the parts life of a Wilden pump. Periodic inspections have been found to offer the best means for preventing unscheduled pump downtime. Personnel familiar with the pump's construction and service should be informed of any abnormalities that are detected during operation.

### Records

When service is required, a record should be made of all necessary repairs and replacements. Over a period of time, such records can become a valuable tool for predicting and preventing future maintenance problems and unscheduled downtime. In addition, accurate records make it possible to identify pumps that are poorly suited to their applications.

## Suggested Installation, Operation, Maintenance and Troubleshooting

### Troubleshooting

#### ***Pump will not run or runs slowly.***

1. Check air inlet screen and air filter for debris.
2. Check for sticking air valve, flush air valve in solvent.
3. Check for worn out air valve. If piston face in air valve is shiny instead of dull, air valve is probably worn beyond working tolerances and must be replaced.
4. Check center block Glyd™ rings. If worn excessively, they will not seal and air will simply flow through pump and out air exhaust. Use only Wilden Glyd™ rings as they are of special construction and ISO 15-5 wt oil with arctic characteristics.
5. Check for rotating piston in air valve.
6. Check type of lubricant being used. A higher viscosity oil than suggested may cause the piston to stick or run erratically. Wilden suggests the use of a hydraulic oil with arctic characteristics (ISO 15-5 wt).

#### ***Pump runs, but little or no product flows.***

1. Check for pump cavitation; slow pump speed down to match thickness of material being pumped.
2. Check for sticking ball checks. If material being pumped is not compatible with pump elastomers, swelling may occur. Replace ball checks and o-rings with proper elastomers.

3. Check to make sure all suction connections are air tight, especially clamp bands around intake balls.

#### ***Pump air valve freezes.***

1. Check for excessive moisture in compressed air. Either install dryer or hot air generator for compressed air.

#### ***Air bubbles in pump discharge.***

1. Check for ruptured diaphragm.
2. Check tightness of clamp bands, especially at intake manifold.

#### ***Product comes out air exhaust.***

1. Check for diaphragm rupture.
2. Check tightness of piston plates to shaft.

#### ***Pump rattles.***

1. See E9 Troubleshooting Guide.
2. Create false discharge head or suction lift.

## Section 7

# Disassembly / Reassembly

## Pump Disassembly

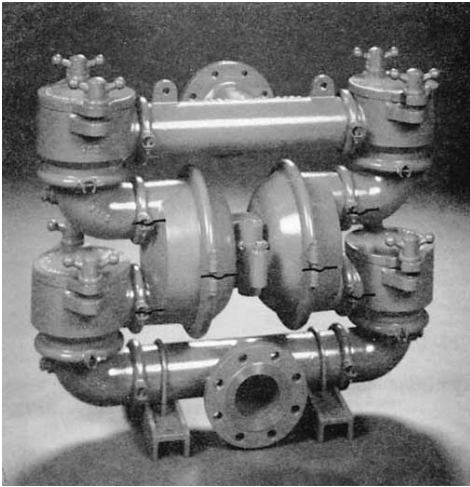

**CAUTION:** Before any maintenance or repair is attempted, the compressed air line to the pump should be disconnected and all air pressure allowed to bleed from pump. Disconnect all intake, discharge and air lines.

The T20 has a 102 mm (4") inlet and 102 mm (4") outlet and is designed for flows up to 300 gpm. Its air distribution system is based upon design simplicity and proven efficiency. The model T20 is available in cast iron.



**NOTE:** Before starting disassembly, mark a line from each liquid chamber to its corresponding air chamber, as well as a line from the liquid chamber to its corresponding discharge elbow and ball pot. These lines will assist in proper alignment during reassembly.

## Disassembly / Reassembly

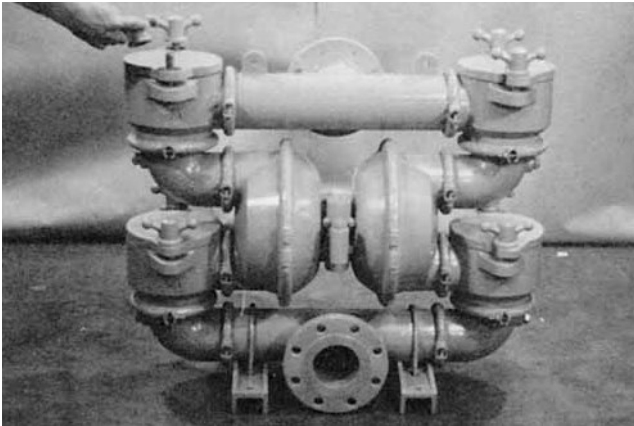

**Step 1**

*Figure 1A*

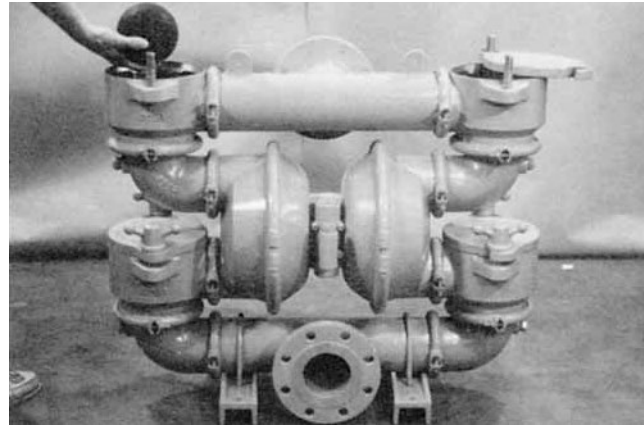

*Figure 1B*

Start disassembly by removing the wing nuts from the ball pots. This allows the ball pot cover to be removed, exposing the discharge or inlet ball valves and ball pot lid o-rings for inspection. (See *Figures 1A, 1B.*)

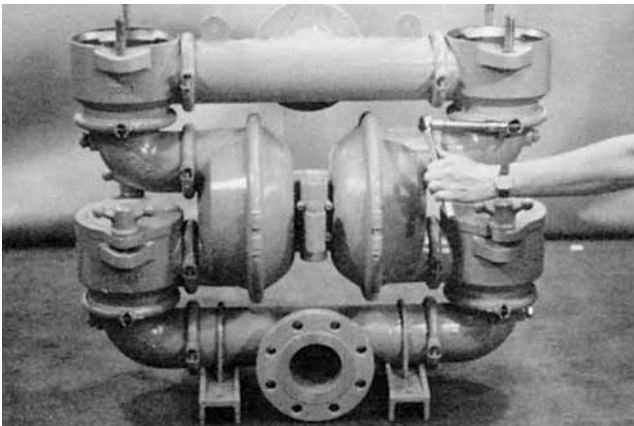

**Step 2**

*Figure 2A*

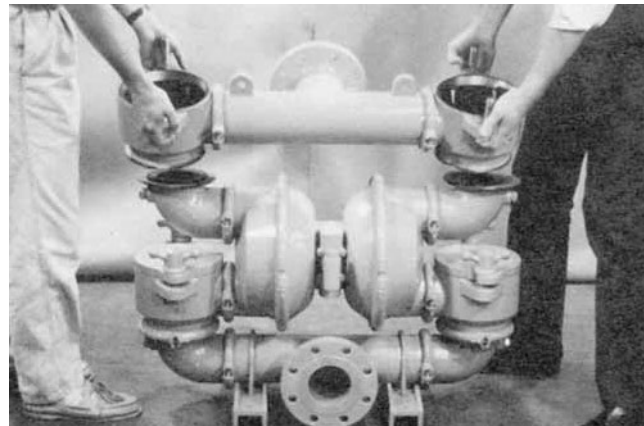

*Figure 2B*

Remove clamp bands around the bottom of discharge ball pots. (See *Figure 2A.*) It is now possible, with assistance, to remove the discharge manifold assembly from the main body of the pump. (See *Figure 2B.*) This allows for inspection of the valve seats.

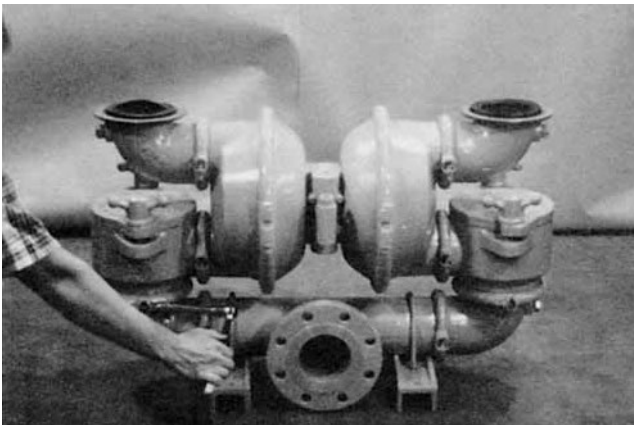

**Step 3**

*Figure 3A*

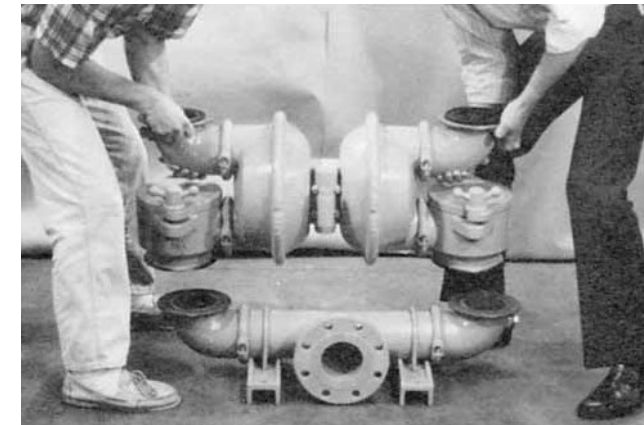

*Figure 3B*

Disconnect clamp bands from around the bottom of the inlet ball pots. (See *Figure 3A.*) It is now possible, with assistance, to remove the main body of the pump. (See *Figure 3B.*) The pump is now in three sections: 1. Inlet housing 2. Center section housing. 3. Discharge housing

## Disassembly / Reassembly

### Disassembly & Reassembly of Inlet Housing

#### Disassembly

Loosen clamp band around inlet elbow. (See Figure 1A.)  
Remove the clamp band while supporting the elbow.  
This step will allow for inspection of the manifold gasket between the elbows and inlet-tee. (See Figure 1B.)  
Repeat this step for removal of opposite elbow.

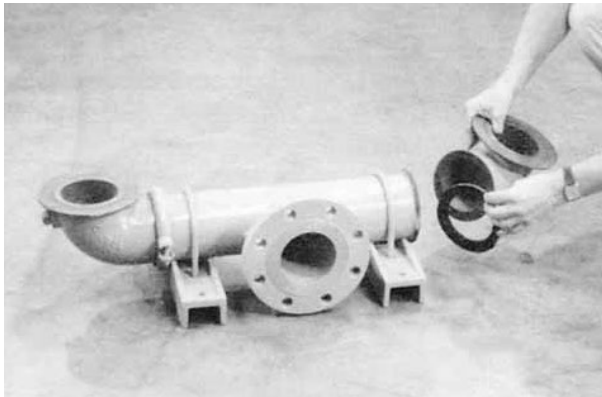
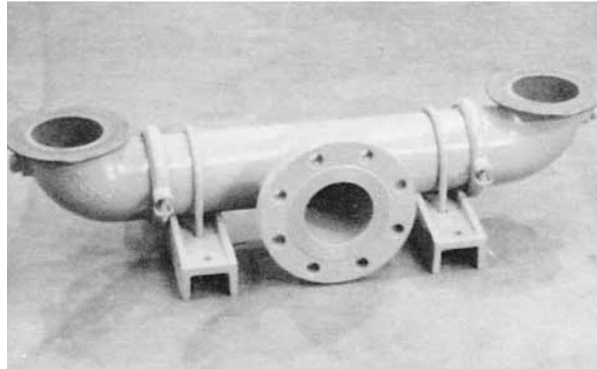

Figure 1A

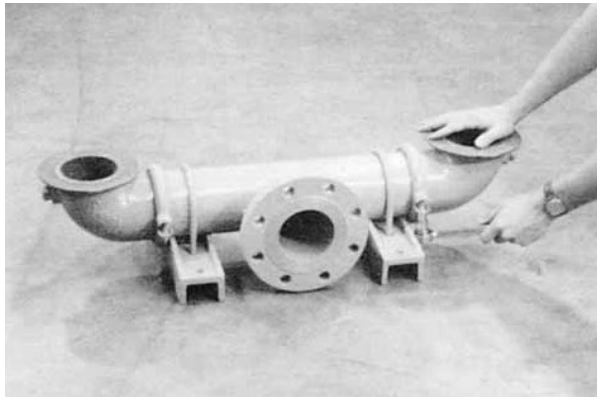

Figure 1B

#### Assembly



Figure 2A

To reassemble, set the tee-section on end. Stretch the gasket lip around the sealing surface of the tee-section. (See Figure 2A.) Align the inlet elbow and replace the clamp band. To reassemble the opposite elbow, balance the assembly on the attached elbow as shown in Figure 2B. This will allow you to look down the length of the manifold giving you the proper perspective to align the elbow not yet attached. Align the second inlet elbow and replace the clamp band.



Figure 2B



**NOTE:** To insure that the elbows are on the same level plane, rest the manifold on its feet and place a straight edge diagonally across the full length of the manifold resting the straight edge on the sealing surface of the elbows. When level tighten clamp bands.

## Disassembly / Reassembly

### Disassembly & Reassembly of Center Section Housing

#### Disassembly

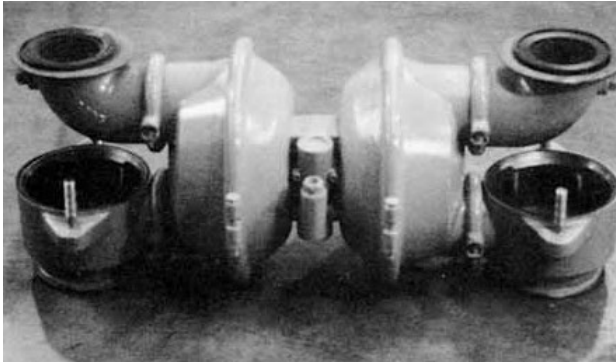

**Step 1**

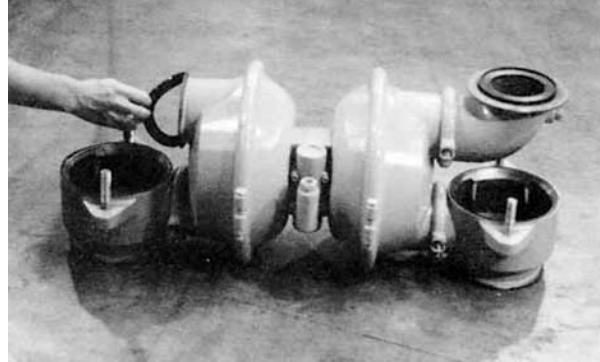

*Figure 1A*

Loosen clamp band around discharge elbow. Remove the clamp band while supporting the elbow. This step will allow for inspection of the manifold gasket between elbows and water chamber. (See *Figure 1A.*) Repeat this step for removal of opposite elbow.

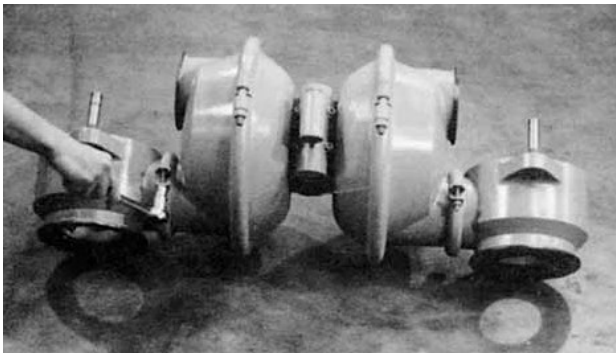

**Step 2**

*Figure 2A*

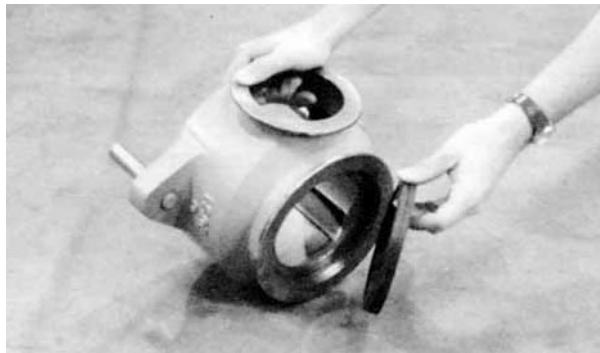

*Figure 2B*

Roll the center housing slightly to achieve better access to the clamp band bolts. (See *Figure 2A.*) Remove the clamp bands connecting the ball pots to the air chamber. This procedure allows inspection of the manifold gasket between the ball pot and water chamber, as well as inspection of the ball seat found on the bottom side of the ball pot. (See *Figure 2B.*)



**NOTE:** You may want to place blocks on each side of the center section. This will prevent the center section from rolling as the ball pots are being removed

#### Step 3

After removing the ball pots set the center section on end. Loosen and remove the clamp. (See *Figure 3A.*) This allows for removal of the water chamber. (See *Figure 3B.*)

With the center section still upright loosen and remove the opposite clamp band. The center section can now be lifted off of the water chamber, exposing both diaphragms for inspection



*Figure 3A*



*Figure 3B*



## Disassembly / Reassembly

### Disassembly & Reassembly of Center Section Housing



**Step 4**

*Figure 4A*

Place the center section as shown in Figure 4A. Place a wrench over the nut at the center of each outer piston, and loosen the outer piston plate.



**Step 5**

*Figure 5A*

Again, place the center section upright so that the diaphragm in the full stroke position is exposed. Using a pry bar, turn the edge of the diaphragm up. (See Figure 5A.) It is now possible to remove the entire diaphragm assembly by unscrewing the outer piston and lifting the assembly off the shaft. (Figure 5B.)



*Figure 5B*

#### **Step 6**

Gently turn the center section over onto the exposed end of the shaft. Gently push down on the center section which will force the shaft through the center block. It will then be possible to grip the edges of the diaphragm and pull the remainder of the shaft through the center block. Unscrew the outer piston and lift the assembly off the shaft. If needed, a vise with wood blocks is the suggested method of securing shaft while removing the second outer piston. It is important not to score or mark the chrome-plated shaft.

#### **Step 7**

To remove the air chamber from the center block simply remove the four flat head screws. This will expose the center block for inspection. Disassembly of the center block and shaft/piston units are shown below.

## Disassembly / Reassembly

### Reassembly of Center Section Housing



#### Step 1

Prior to reassembly, remove Glyd™ rings from center block bushing and flush the center block, removing grit and contaminants. Install new Glyd™ rings in center block. Reassemble air valve, center block and air chambers per the torque specifications\*.

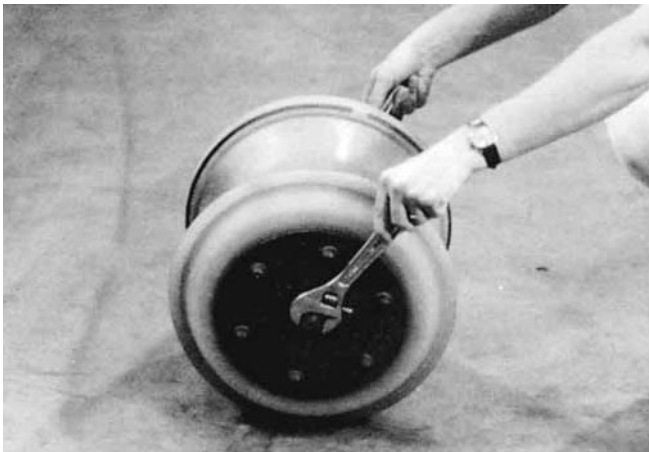

#### Step 2

Figure 2A

Pre-assemble the inner piston, diaphragm and outer piston per the torque specifications\*. Attach the pre-assembled diaphragm configuration to either end of the shaft. Lubricate the bushing with a 5W non-synthetic, non-detergent oil so that the shaft will pass through the Glyd™ rings. Insert the shaft firmly into the bushing. Turn the center section over and push the diaphragm from full stroke position to exhaust position. This will expose the shaft so that the other pre-assembled diaphragm configuration can be positioned. (See Figure 2A.)

\*Refer to Section 8 for required torque specifications



#### Step 3

Figure 2B

Attach the other pre-assembled diaphragm configuration to the other end of the shaft. After installation of the diaphragm, tighten the outer pistons by laying the assembly horizontally and tightening both outer pistons simultaneously per torque specification\*. (See Figure 2A.)

## Disassembly / Reassembly

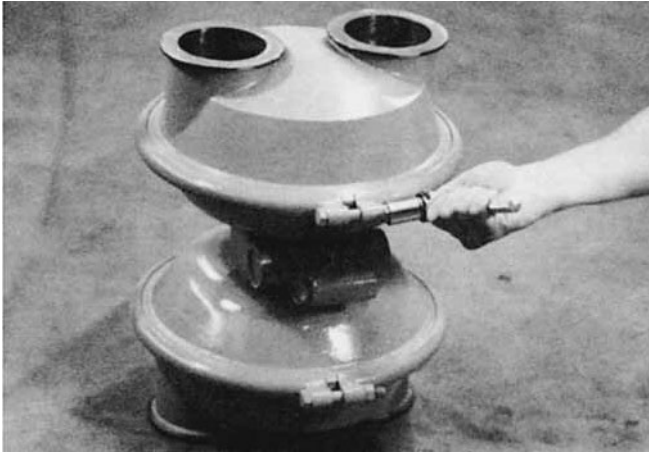

**Step 4**

*Figure 4A*

Return the pump to an upright position. (See *Figure 4A.*) Replace gaskets on both sealing surfaces of the water chamber. Realign one discharge elbow and ball pot. Replace the clamp bands and tighten per the torque specification\*.

\*Refer to Section 8 for required torque specifications



**Step 5**

*Figure 5B*

Flip the assembly over and stand the unit upright using a block of wood to support the assembly. (See *Figure 5A.*) Replace the gaskets. Realign the discharge elbow and ball pot.

## Disassembly / Reassembly

### Disassembly & Reassembly of Discharge Housing

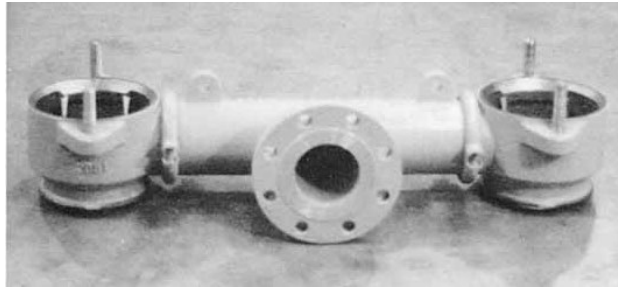

#### DISASSEMBLY

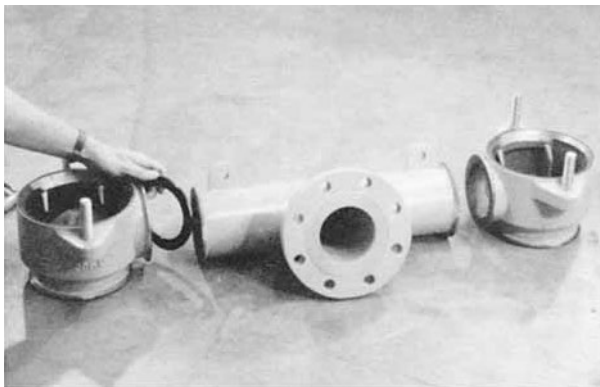

**Step 1**

*Figure 1A*



*Figure 1B*

Loosen clamp bands between ball pots and discharge tee. Remove the bands while supporting the tee-section. This will allow for inspection of the seals between the ball pots and discharge tee-section (see *Figure 1A*) as well as inspection of the ball seat found on the bottom side of the ball pot. (See *Figure 1B*.)

#### REASSEMBLY

##### Step 1

To reassemble the discharge housing, set the tee-section on end. Stretch the gasket lip around the sealing surface of the tee-section. (See *Figure 1C*.) Align the ball pot and replace the clamp band (hand tighten only). To reassemble the opposite ball pot, balance the discharge tee on the attached ball pot as shown in *Figure 1D*. Align the ball pot and attach the clamp band. (Hand tighten only.)



**NOTE:** To insure that the ball pots are on the same level plane, rest the manifold horizontally and place a straight edge diagonally across the full length of the manifold resting the straight edge on the sealing surface of the ball pots. When level tighten clamp bands per the torque specification\*.



*Figure 1C*



*Figure 1D*

## Disassembly / Reassembly

### Reassembly of Pump Body

#### **Step 1**

With assistance, place the center section housing onto the inlet manifold. Replace clamp bands around the inlet elbows and ball pots and tighten per the torque specification\*.

#### **Step 2**

With assistance, place the discharge assembly onto the discharge elbows. Replace the clamp bands around the discharge elbows and ball pots and tighten per the torque specification\*.

#### **Step 3**

Place the valve balls into the ball pots, replace the ball pot plate o-ring and the ball pot plate. Hand-tighten the wing nuts.

## Disassembly / Reassembly

### Air Valve / Center Section Disassembly

The air valve assembly consists of both the air valve body and piston and the center block. The unique design of the air valve relies only on differential pressure to effect the diaphragm shift. It is reliable and simple to maintain. The bushing in the center block, along with the diaphragm shaft, provides the “trigger” to tell the air valve to shift. The following procedure will ensure that the air valve on your Wilden pump will provide long trouble-free service.

#### AIR VALVE BODY AND PISTON ASSEMBLY AND DISASSEMBLY

The air valve can be disconnected from the pump by removing the four socket head cap screws which attach it to the center block. The piston should move freely and the ports in the piston should line up with the ports on the face of the air valve body (see *Figure D*). The piston should also appear to be dull, dark gray in color. If the piston appears to be a shiny aluminum color, the air valve is probably worn beyond working tolerances and should be replaced.

If the piston does not move freely in the air valve, the entire air valve should be immersed in a cleaning solution.

**NOTE:** Do not force the piston by inserting a metal object.

This soaking should remove any accumulation of sludge and grit which is preventing the air valve piston from moving freely. Also, remove and clean the air valve screen.

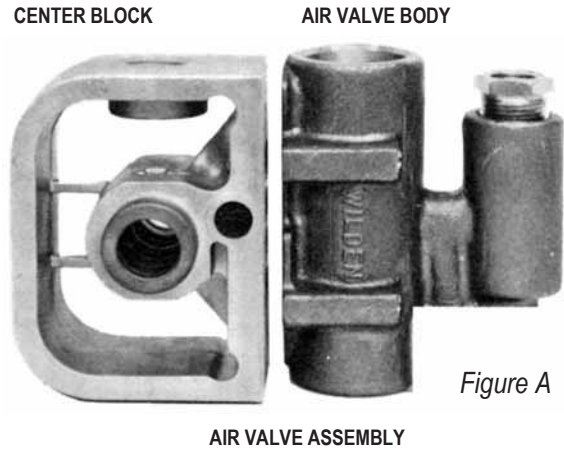

*Figure A*

If the air valve piston does not move freely after the above cleaning, the air valve should be disassembled as follows: Remove the snap ring from the top end of the air valve cylinder and apply an air jet to the 3/16-inch hole on the opposite end of the air valve face (see *Figure C*).

**CAUTION:** The air valve end cap may come out with considerable force. Inspect the piston and cylinder bore for nicks and scoring.

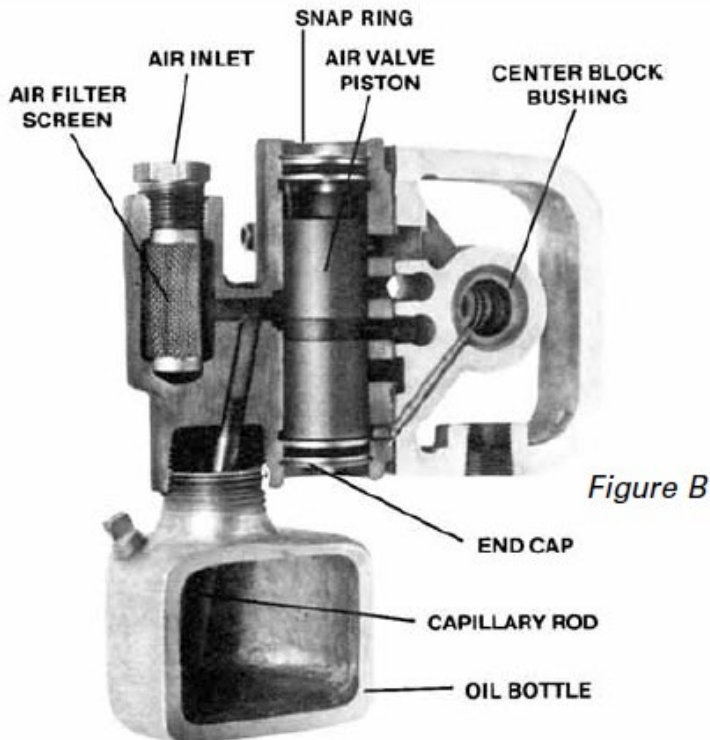

*Figure B*

#### GLYD™ RING REPLACEMENT:

When the Glyd™ rings become worn, they will no longer seal and must be replaced. Due to the design characteristics of the Glyd™ rings, it is suggested that you use the Ringer Seal installation kit when replacing Glyd™ rings. Consult EOM- Ringer for installation instructions.

#### CENTER BLOCK ASSEMBLY:

The pump's center block consists of a die cast housing with a cast-in-bronze bushing. The bushing has eleven grooves cut on the inside diameter. Since these Glyd™ rings form a part of the shifting function of the pump, it is necessary that they be located in the proper grooves. The bronze bushing is replaceable in cast iron center block only. When bushing wear becomes excessive, a new center block must be used.

This soaking should remove any accumulation of sludge and grit which is preventing the air valve piston from moving freely. Also, remove and clean the air valve screen.

## Disassembly / Reassembly

### MAXIMUM TORQUE SPECIFICATIONS

Item #	Description of Part	Maximum Torque
1	Air Valve	9.0 N•m (80 in-lbs)
2	Outer Piston	135.6 N•m (100 ft-lbs)
3	2C Ring & Piston	19.0 N•m (14 ft-lbs)
4	Center Block Assembly	24.4 N•m (18 ft-lbs)
5	Large Clamp Bands	61.0 N•m (45 ft-lbs)
6	Small & Medium Clamp Bands	17.6 N•m (13 ft-lbs)
7	Wing Nut	—
8	U-Bolt	44.7 N•m (33 ft-lbs)
9	Prime Plug	105.8 N•m (78 ft-lbs)

**Section 9**

**EXPLODED VIEW AND PARTS LISTING**

**T20 ORIGINAL™ METAL**

**EXPLODED VIEW**

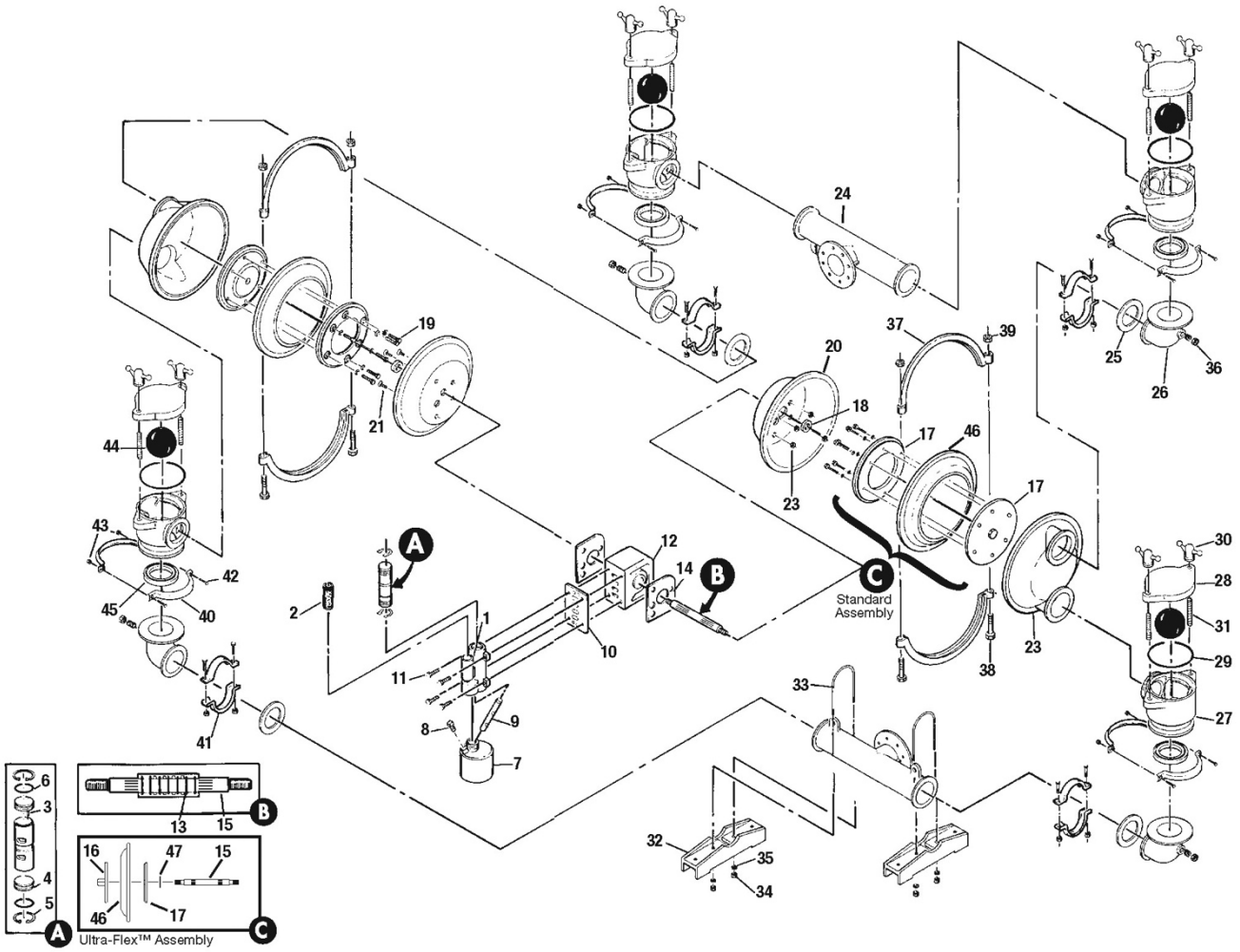



## Exploded View and Parts List

Item	Description	Qty.	T20/WWWAB P/N
<b>1</b>	<b>Air Valve Assembly</b>	<b>1</b>	<b>15-2080-07</b>
2	Air Valve Screen	1	08-2500-07
3	Air Valve End Cap with Guide	1	15-2300-23
4	Air Valve End Cap without Guide	1	15-2330-23
5	Air Valve Snap Ring	2	15-2650-03
6	Air Valve Cap O-Ring	2	15-2390-52
7	Oil Bottle	1	15-2850-01
8	Plug	1	08-7000-07
9	Capillary Rod	1	15-2900-99
10	Air Valve Gasket — Buna-N	1	15-2600-52
11	Air Valve Screws	4	08-6000-08
12	Center Block	1	15-3100-01-225
<b>13</b>	<b>Center Block Glyd™ Ring</b>	<b>7</b>	<b>15-3210-55-225</b>
14	Block Gasket — Buna-N	2	15-3520-52
15	Shaft	1	20-3800-09-07
	Shaft, Ultra-Flex™	1	20-3830-09-07
16	Piston, Outer	2	20-4550-02
	Piston, Outer, Ultra-Flex™	2	20-4560-02
17	Piston, Inner	2	15-3700-01
	Piston, Inner, Ultra-Flex™	2	15-3760-08
18	Washer, Inner Piston Back-Up	2	15-6850-08
19	Piston Assembly — Bolt & Washer	12	15-6130-08/15-6720-08
20	Air Chamber	2	15-3650-02
21	Air Chamber — Screw	4	15-6200-08
22	Air Chamber — Nut	4	08-6550-08
23	Liquid Chamber	2	20-5000-02
24	Tee Manifold	2	20-5160-02
25	Manifold Gaskets	8	*
26	Elbow	4	20-5220-02
27	Pot	4	20-5460-02
28	Plate	4	20-5480-02
<b>29</b>	<b>Plate O-Ring</b>	<b>4</b>	<b>*</b>
30	Wing Nut	8	20-6690-02
31	Wing Nut Stud	8	20-6160-08
32	Foot	2	20-5540-02
33	U-Bolt	2	20-6300-08
34	U-Bolt Nut	4	15-6420-08
35	U-Bolt Lock Washer	4	20-6750-08
36	Pipe Plug — 3/4"	4	20-7010-07
37	Large Clamp Band Assy.	2	15-7300-03
38	Large Carriage Bolt	4	15-6120-03
39	Large Hex Nut	4	15-6420-03
40	Medium Clamp Band Assy.	4	20-7200-03
41	Small Clamp Band <sup>1</sup>	8	20-7100-03
42	Medium Carriage Bolt	24	04-6070-03
43	Medium Hex Nut	24	08-6400-03
<b>44</b>	<b>Valve Ball</b>	<b>4</b>	<b>*</b>
<b>45</b>	<b>Valve Ball Seat</b>	<b>4</b>	<b>*</b>
<b>46</b>	<b>Diaphragm</b>	<b>2</b>	<b>*</b>
47	Spacer, Ultra-Flex™	2	15-6850-08
	Muffler (Not shown)	1	15-3510-99

<sup>1</sup>Small clamp band uses medium carriage bolt (04-6070-03) and medium hex-nut (08-6400-03).

\*Refer to corresponding elastomer chart in Section 8.

All boldface items are primary wear parts.

**Section 9**

**Elastomer Options**

**T20 Metal Pumps**

Material	Diaphragm (2) P/N	Ultra-Flex® Diaphragm (2) P/N	Valve Ball (4) P/N	Valve Seat (4) P/N	Plate O-Ring (4) P/N	Manifold Gasket (8) P/N
Polyurethane	15-1010-50		20-1080-50	20-1120-50		
Neoprene		15-1020-51				
Buna-N	15-1010-52	15-1020-52				
FKM®	15-1010-53	15-1020-53		20-1120-53	20-1250-53	20-1400-53
EPDM	15-1010-54	15-1020-54				20-1400-54
PTFE			20-1080-55			
Saniflex™	15-1010-56					
Wil-Flex™	15-1010-58					

**Notes**

PSG  
22069 Van Buren Street  
Grand Terrace, CA 92313-5651 USA  
P: +1 (909) 422-1730 • F: +1 (909) 783-3440  
psgdover.com



Where Innovation Flows